

# PORT FO LIO.



 MANUFACTURED  
IN EUROPE

 **CIARKO**<sup>®</sup>

KITCHEN COOKER HOODS AND HOBS



# TABLE OF CONTENT

WHO  
WE  
ARE?

**3.**

TECHNO-  
LOGY

**10.**

BUILT-IN  
HOODS

**27.**

PULL-OUT  
HOODS

**41.**

BUILT-  
UNDER  
HOODS

**47.**

CHIMNEY  
HOODS **51.**

ISLAND  
HOODS **73.**

COUNTER-  
TOP HOODS **B3.**

INDUCTION  
HOBS **B7.**

CIARKO  
DESIGN **91.**





 **CIARKO**



**WHO  
WE  
ARE?**



**3.**

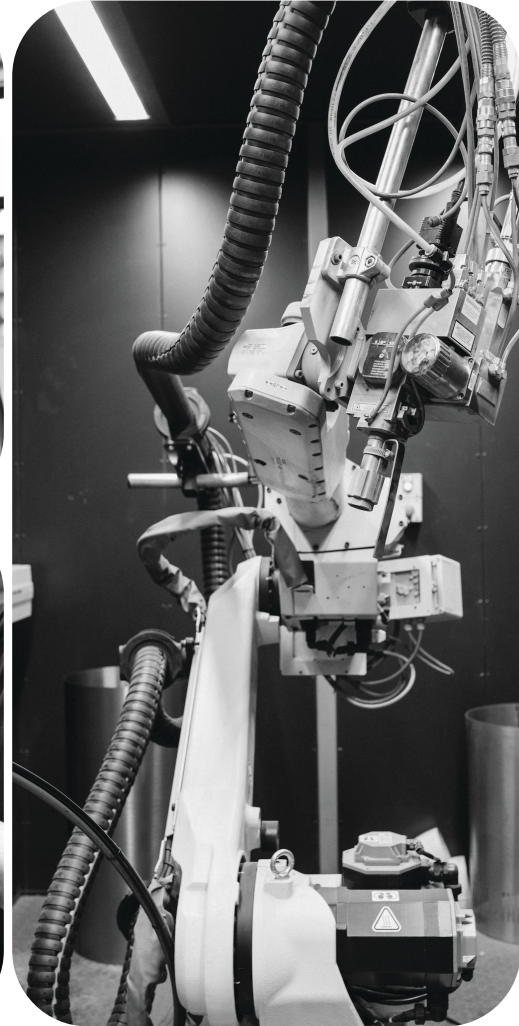



**We are Ciarko family.  
Biggest cooker hood producer in Poland.**

We proudly design exclusively **in Poland**. We manufacture up to **3,500** cooker hoods per day, utilizing more than **20,000** square meters of production space. All hoods are fully designed and manufactured by our team of over **500** employees.

**Ciarko** is a **family company** not only because of its founder. Throughout the organization, more than **100 families** help create the **Ciarko** brand **every day**, ensuring the unquestionable quality of our products. From the very beginning, the company's mission has been sustainable development and environmental protection.

This year, the company will make an investment in renewable energy that will reduce the consumption of electricity produced during operation, **up to 80%!**

The brand's products have been **appreciated in over 48 markets worldwide**, and technologies (among other things, gesture-controlled hood, air ventilation function) allow to improve the quality of time spent in the kitchen for millions of people around the world every year!

# PRODUCTS.

**WIDE RANGE OF COLORS**



**100% SOLID STEEL CONSTRUCTION**

**MANY FILTRATION OPTIONS**

**DESIGNED AND MANUFACTURED IN EUROPE**

**SLEEK AND MODERN DESIGN**



**FULLY DESIGNED AND  
MANUFACTURED IN THE EU**

**EFFICIENT AND SILENT  
VARIETY OF MOTORS**

**ENERGY-SAVING  
LIGHTING OPTIONS**

**SMART CONNECT (IR, RF AND  
BLUETOOTH COMMUNICATION  
SYSTEM)**

**POWERFUL HEATING COILS**

**USER-FRIENDLY COOKING FEATURES**



# PRODUCT LINES.



## BASIC

In our **Ciarko Basic** Line we would like to showcase a great selection of economical hoods. Cooker hoods from **Ciarko Basic** line are widely associated with functions and efficiency essential for daily use. This range of cooker hoods is dedicated especially for small-sized kitchens and hobs, which means that these hoods are produced in 50 or 60 cm width concerning the size and most models are equipped with mechanical control function. We offer **Ciarko Basic** products in **high-volume orders**.

## COMFORT

In our **Ciarko Comfort** Line we offer customized cooker hoods with modern design in different sizes. **Ciarko Comfort** offers a wide range of products featuring quality glass and stainless steel together with modern electronic control panels which means multifunctionality and high efficiency for the user. The Customer has the possibility to specify the hoods by selecting the Motor Efficiency (Energy class and Airflow), LED Lighting and Filter Quality. **Ciarko Comfort** is a perfect blend of high quality and affordability. The Comfort Line products are available at **mid-volume orders**.

## PREMIUM

**Ciarko Premium** is our prestigious line of the highest quality standards in cooker hoods, for which we were rewarded with many prestigious prizes. As the name suggests this is the most advanced category; products are equipped with cutting-edge technology such as smell sensors, gesture control or brushless motors which are described as energy saving and almost inaudible on first gears. In this category we combine newest technology with unique design. In **Premium** line we offer many advanced hoods in range of: Ceiling, Downdraft, Built-in, Island and Vertical cooker hoods. The Premium hoods are available at **low-volume orders**. Some of them are available exclusively through Ciarko Design.

## CIARKO DESIGN

**Ciarko Design** is made for those who want the best. It's built on over 35 years of **experience and knowledge from 48 countries**, mixing advanced technology with the world class design. It's all about making cooker hoods **amazing and stylish**, perfect for people who love things that look good and work great.

# TECHNOLOGY.



## MOTOR SECTION:

- AC Motors
- BLDC Motors

MORE INFO ON **PAGE: 12**



## MOTOR SOLUTION:

- Integrated
- External Indoor & Outdoor Motor

MORE INFO ON **PAGE: 14**



## FILTERING SECTION:

- Charcoal filter
- High-performance Long-Life filter
- Plasma filtering

MORE INFO ON **PAGE: 16**



## **SENSORS:**

- Steam & Smell sensor
- Smart connect (IR, radio and Bluetooth communication system)
- Air cleaning Sensor with Plasma filter

MORE INFO ON **PAGE: 18**



## **LIGHTING:**

- Dynamic LED Warm 2 cold
- LED dimming

MORE INFO ON **PAGE: 20**

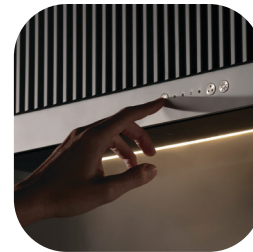

## **CONTROL PANELS:**

- Mechanical Controls
- Electronic Push buttons
- Touch Controls
- Gesture Controls

MORE INFO ON **PAGE: 22**



## **REMOTE CONTROL:**

- Radio Remote Control
- Infrared Remote Control

MORE INFO ON **PAGE: 24**



**AC MOTOR**

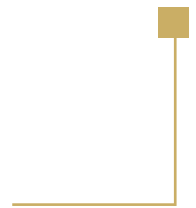
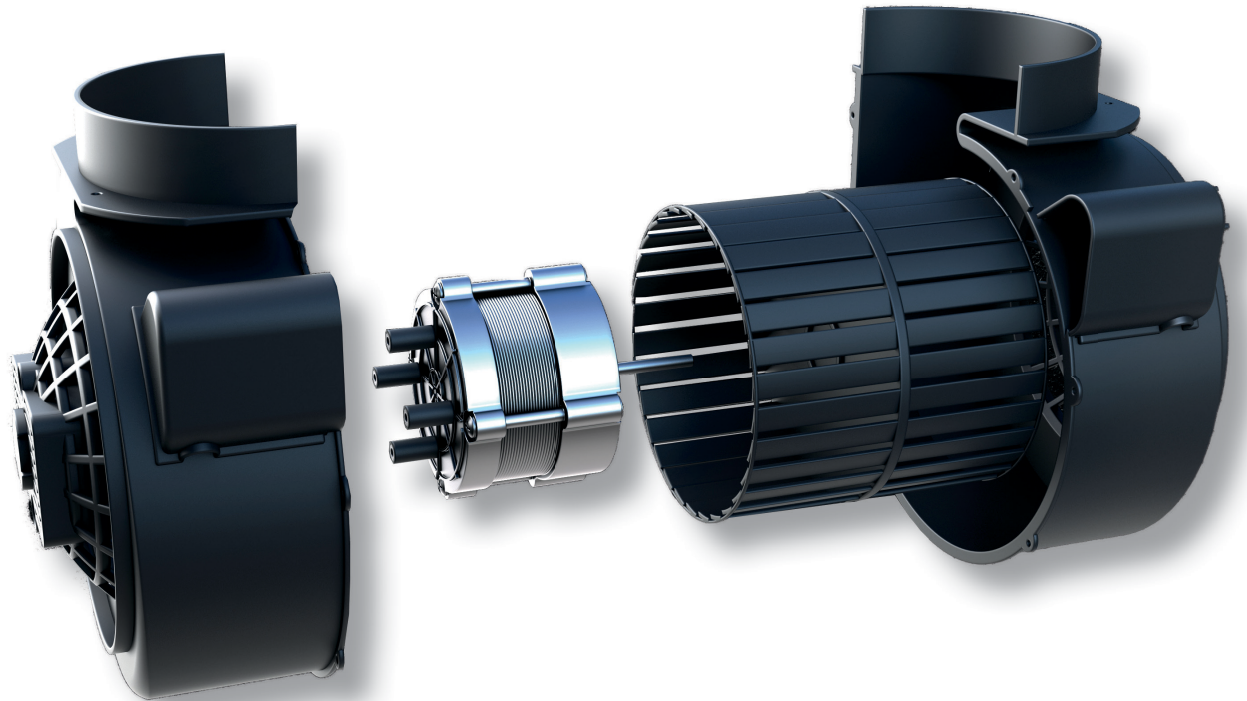

**BLDC MOTOR**



# TYPE OF MOTORS.

## AC MOTOR

The **AC motor** for range hoods ensures powerful and efficient air extraction, keeping your kitchen free from smoke, odors, and grease. It operates quietly and reliably, providing long-lasting performance and consistent airflow.

## BLDC MOTOR

The **brushless motor** for range hoods delivers high performance with exceptional energy efficiency and quiet operation. Its advanced technology ensures reliable, long-lasting functionality while maintaining powerful and consistent airflow. Designed for modern kitchens, it offers a high-performance, eco-friendly solution for effective and silent ventilation.

What do we look for when buying a kitchen hood? Reliable studies show that we focus primarily on volume and performance. Knowing these needs and with many years of experience behind us, we offer products, perfectly matching the features you are looking for. The technology developed by Ciarko and the knowledge of engineers from the Warsaw University of Technology resulted in the creation of the unique **BLDC Motor**.

It is extremely quiet during operation, and also achieves an energy class of **A+++**, which **reduces energy consumption by up to 95%**. Its operation in the first gear, when it needs only **8 W**, can be compared to the energy consumed by a single **small light bulb**. Thanks to the innovative housing, we can reduce the noise level of the hood during operation by as much as **6 dB!** What does this mean in practice? Among other things, the fact that it will not interfere with our conversations, and this is a huge advantage that is becoming our standard. **Ciarko was one of the first brands on the market to lower the volume level of hoods below 40 dB.**

**Depending on the selected motor, the performance will vary for each hood. The performance values in the portfolio are provided as an indication.\***

# INTEGRATED EXTERNAL MOTOR.

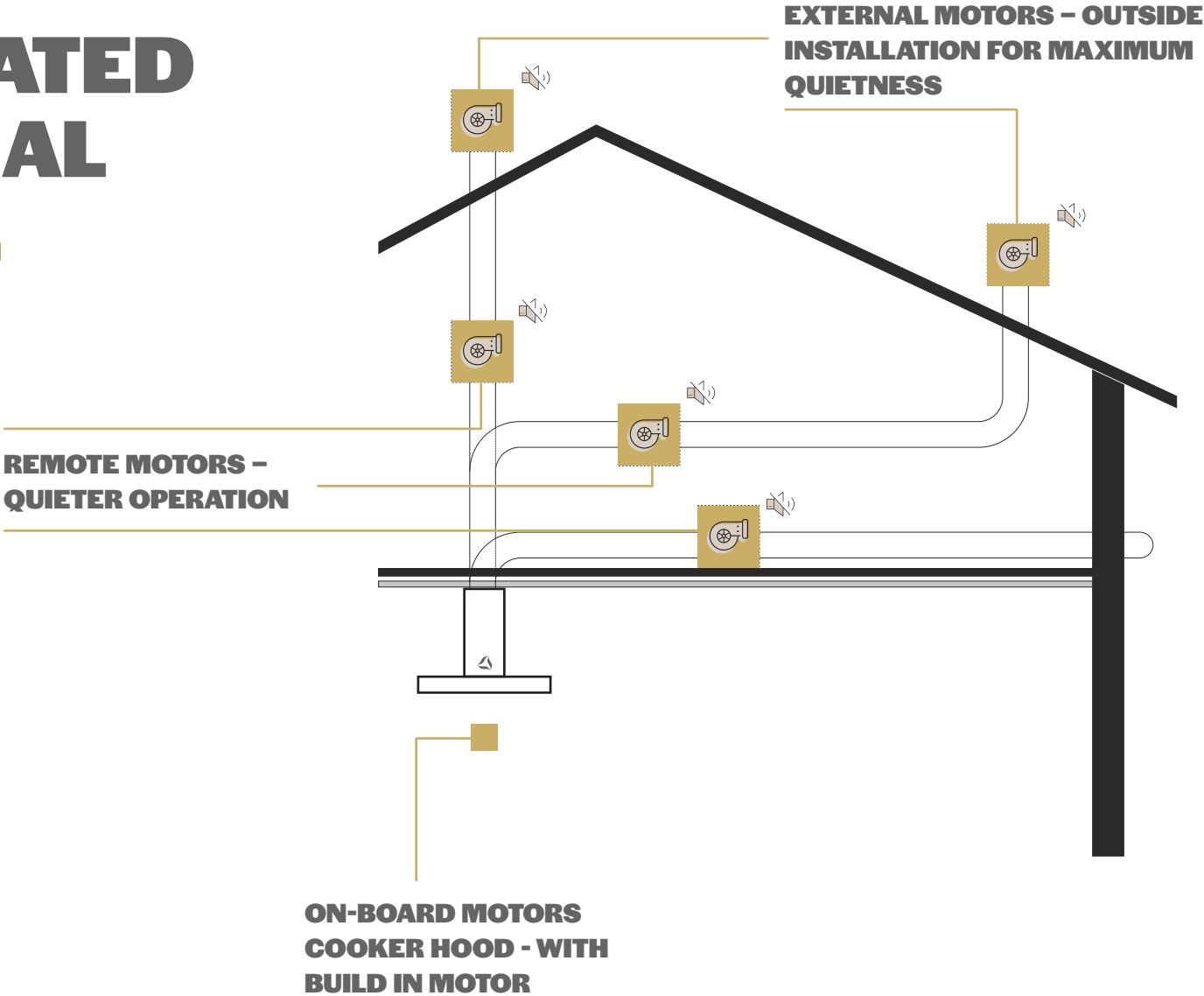



# MOTOR SOLUTION.

We offer different motor solutions for range hoods to ensure powerful ventilation, flexibility, and reduced noise. Whether the motor is inside the hood or placed outside for a quieter kitchen, our solutions provide efficient and reliable performance.

## **1. On-Board Motors – Built into the Hood**

Our on-board motors are installed directly inside the range hood. This is a compact and simple solution that provides strong ventilation without extra installation effort.

## **2. Remote Motors – Quieter Operation**

For a quieter kitchen, our remote motor solutions allow the motor to be placed up to 8 meters away from the hood. The motor can be installed in another location, such as a cabinet, attic, or technical room. This reduces noise while maintaining strong suction power.

## **3. External Motors – Outside Installation for Maximum Quietness**

For the quietest and most powerful option, we offer electronic solutions that can be connected to external motors installed outside the house, usually on the roof or an exterior wall. This keeps the noise completely away while ensuring excellent ventilation.

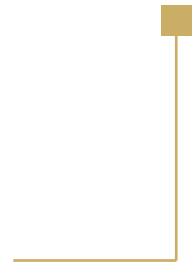
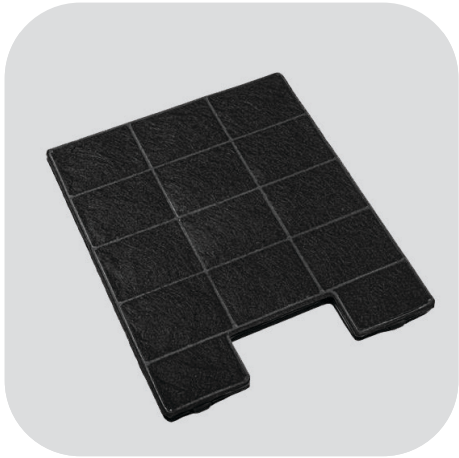

**CHARCOAL  
FILTERS**

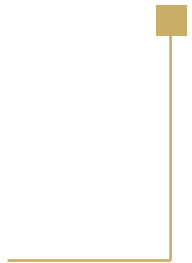

**HIGH-  
PERFORMANCE  
LONG-LIFE FILTERS**

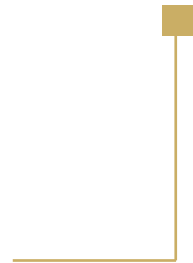
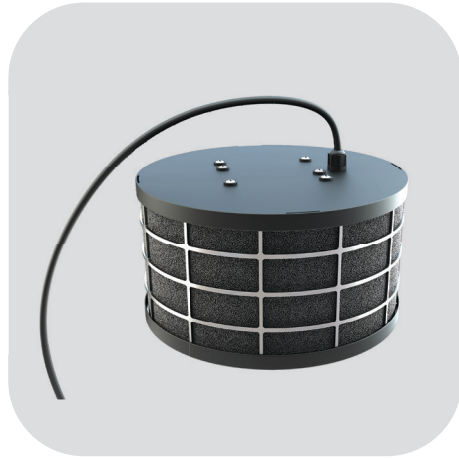

**PLASMA  
FILTERS**

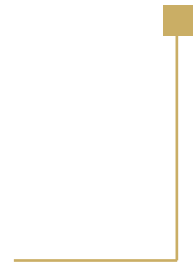

**BAFFLE  
FILTERS**



# FILTERING.

Cooker hoods improve kitchen air **quality by filtering** out grease, moisture, and odors. While extraction hoods push (filtered air) directly outside, recirculating hoods use different filter systems to clean and return the air to the room. Various filter solutions are available, each of them with different benefits and maintenance requirements.

## 1. Activated Carbon Filter

### Function & Benefits:

- Absorbs and neutralizes unpleasant odors.
- Improves air quality in recirculation mode.
- Needs to be replaced every 3–6 months.

## 2. Long-Life Activated Carbon Filters

### Function & Benefits:

- Can be regenerated by heating in an oven.
- Lasts up to 3 years.
- Saves long-term costs and reduces waste.
- Effectively removes odors.

## 3. Plasma Filter

### Function & Benefits:

- Converts odor molecules into oxygen, water vapor, and carbon dioxide.
- Removes not only odors but also bacteria and pollutants.
- Extremely durable (often up to 10 years with little to no maintenance).
- Ideal for allergy sufferers or those with high hygiene standards.
- Higher initial cost but economical in the long run.

## 4. Baffle Filters

### Function & Benefits:

- Made of durable stainless steel.
- Commonly used in professional kitchens.
- Improves air purification.
- Extends the lifespan of the ventilation system.
- Resistant to corrosion.
- Easy to clean, suitable for demanding users.

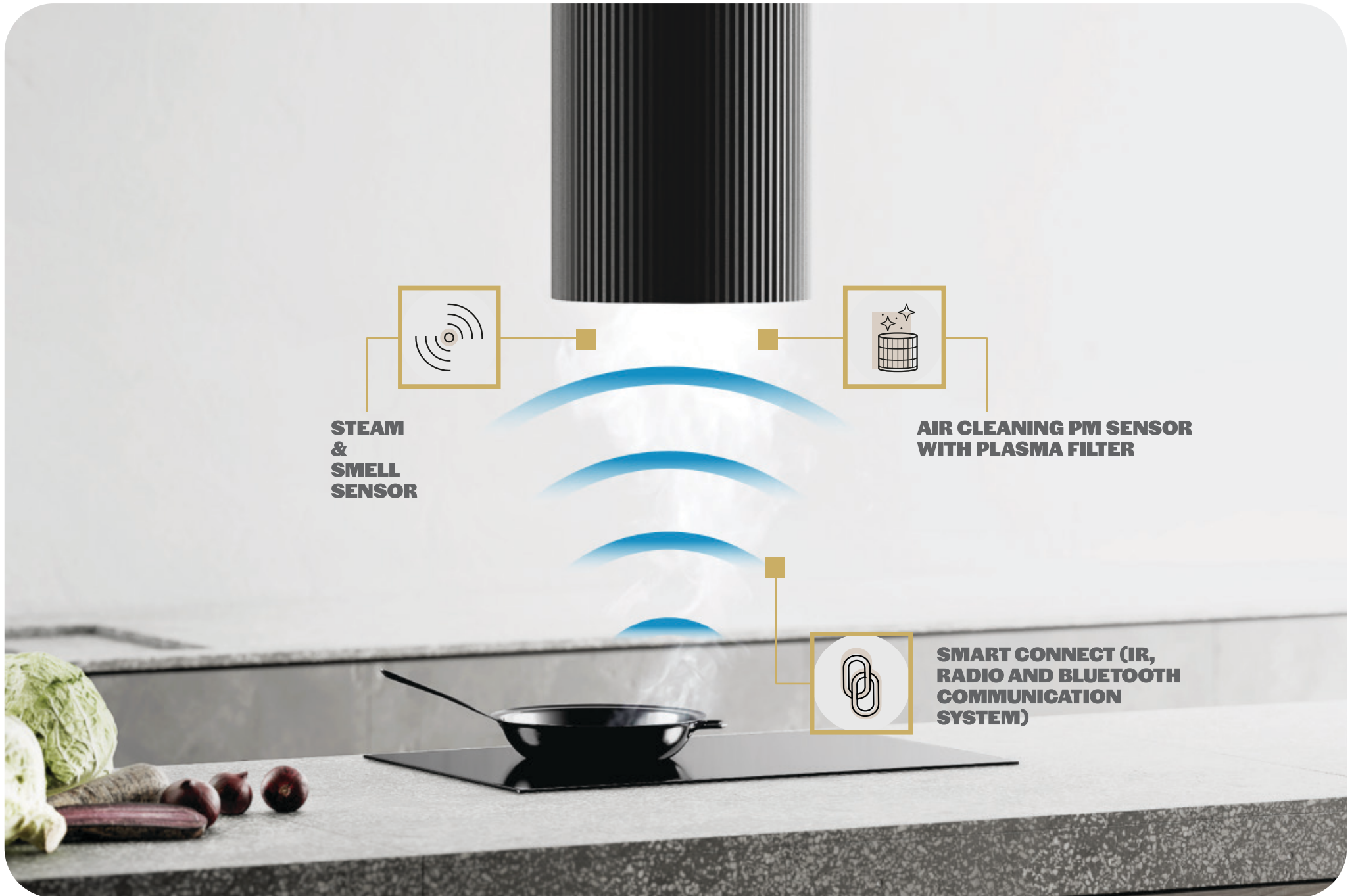

**STEAM  
&  
SMELL  
SENSOR**

**AIR CLEANING PM SENSOR  
WITH PLASMA FILTER**

**SMART CONNECT (IR,  
RADIO AND BLUETOOTH  
COMMUNICATION  
SYSTEM)**



# SENSORS.

## **AiSense Intelligent Sensor in Cooker Hoods**

Upgrade your kitchen with our Intelligent Sensor. It constantly monitors humidity, temperature, and VOC (volatile organic compounds) levels to keep your kitchen fresh and comfortable.

### **How It Works**

The sensor uses smart technology to instantly check air quality. When it detects changes, the hood automatically adjusts its speed from 1 to 3 to remove odors and excess moisture without any manual input.

### **Smart Learning**

Over time, the sensor learns your cooking habits. Each time you cook, it better understands your preferences and adjusts the hood to match your lifestyle, providing a personalized ventilation experience.

## **Smart Connect**

### **(IR, radio and Bluetooth communication system)**

Touchless harmony between the cooktop and the hood eliminates manual control! Automatic power adjustment ensures optimal hood performance based on cooking intensity without the need for manual setting changes, while still allowing users to deactivate this function if desired. Additionally, the hood can be controlled directly from the induction cooktop, providing seamless integration and effortless operation.

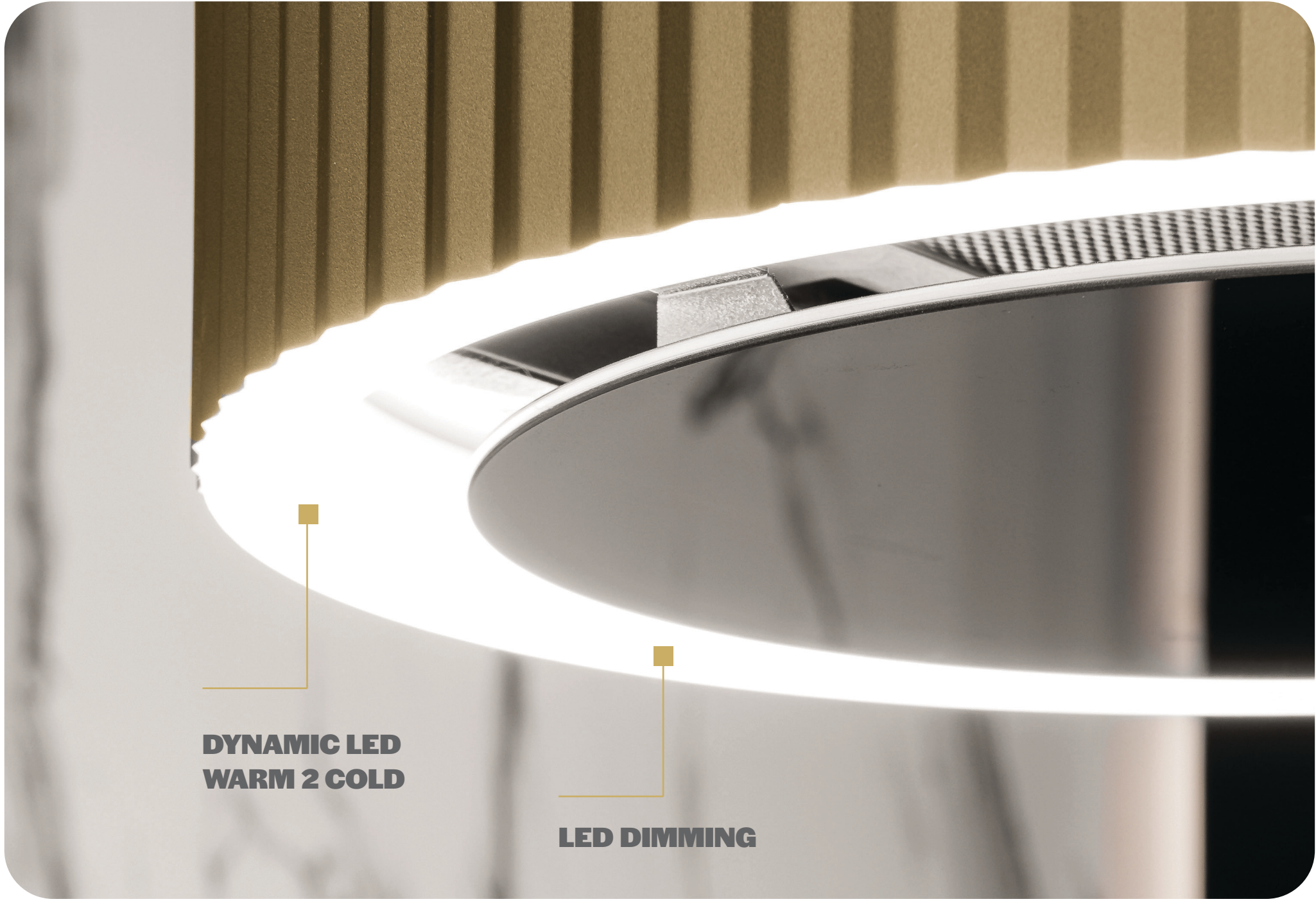

**DYNAMIC LED  
WARM 2 COLD**

**LED DIMMING**

# COLD, WARM, WARMER.

If you hesitate whether to choose a warm or cool light colour together with Ciarko you can resolve this dilemma once and for all. **Warm2ColdLED** technology gives us the option to adjust the light colour from **2900K to 6000K**. Warm light, close to sunlight, does not tire the eyes, improving our well-being; while cooler light allows us to expose details and emphasizes the character of the interior. In addition to endless possibilities in kitchen design, **Warm2coldLED** has another advantage: it illuminates the workspace with minimal power consumption. And this is true regardless of the time of day or the weather conditions outside the window.



6000K



2900K

**MECHANICAL  
CONTROL**



**TOUCH  
CONTROL**



**GESTURE  
CONTROL**



**ELECTRONIC  
CONTROL**





# INNOVATIVE HOOD CONTROL SYSTEM.

## Innovative Control Solutions for Range Hoods

Our range hoods are designed for maximum comfort, efficiency, and ease of use, offering a variety of control options to suit different needs. From simple mechanical switches to advanced gesture controls, our innovative solutions provide smooth operation and modern convenience.

### 1. Mechanical Control – Simple & Reliable

For those who prefer a straightforward and durable solution, our mechanical control option offers easy operation with classic push buttons, rocker switches or rotary switches.

### 2. Soft-Touch Electronic Control – Effortless & Modern

Our electronic soft-touch control provides a smooth and precise way to adjust fan speed and lighting. A subtle press of the buttons provides effortless operation with a sleek and modern design.

### 3. Touch Control – Elegant & Smart

For a high-end, seamless experience, our glass touch control offers an elegant, fully integrated interface. A simple tap on the sleek glass panel activates the hood's functions, providing a high-tech and sophisticated look.

### 4. Gesture Control – Hands-Free Convenience

Experience the ultimate convenience with our gesture control technology. A simple hand movement is enough to turn the hood on or off, adjust the fan speed, or control the lighting—perfect for busy kitchens when hands are messy or occupied.



**RADIO  
REMOTE  
CONTROL**

**IR REMOTE  
CONTROL**



# REMOTE CONTROL.

## **Remote Controls**

Our cooker hoods can be paired with radio control and an IR remote for easy operation. These remote functions include motor control, lighting options, and a timer. Thanks to the magnetic construction, the remote controls can be easily attached directly to the hood.

**RF Remote:** The RF remote allows operation from a greater distance without requiring a direct signal path to the hood's control unit.

**IR Remote:** The IR remote requires an unobstructed signal path to the hood's control unit to function properly.













# BUILT-IN HOODS



**27.** 



**SL-BOX ECO**





-  **FINISH:**  
Black / White / Inox
-  **CONTROLS:**  
Push - push
-  **LIGHTING:**  
1x Candle LED bulb
-  **GREASE FILTER:**  
Aluminium
-  **AIR OUTLET:**  
120 / 150 mm
-  **WIDTH:**  
60 cm
-  **ACCESSORIES:**  
Carbon filter
-  **EFFICIENCY:**  
190 m3/h



**BASIC**



**SL-BOX ECO STRIPE**

-  **FINISH:**  
Black / White / Inox
-  **CONTROLS:**  
Push - push
-  **LIGHTING:**  
1 x 3 W LED Stripe
-  **GREASE FILTER:**  
Aluminium
-  **AIR OUTLET:**  
120 / 150 mm
-  **WIDTH:**  
60 cm
-  **ACCESSORIES:**  
Carbon filter
-  **EFFICIENCY:**  
280 m3/h



**BASIC**



**SL-BOX**

-  **FINISH:**  
Black / White / Inox
-  **CONTROLS:**  
Push - push
-  **LIGHTING:**  
2 x 3 W GU10 LED Spot
-  **GREASE FILTER:**  
Aluminium
-  **AIR OUTLET:**  
120 / 150 mm
-  **WIDTH:**  
45 / 50 / 60 / 72 / 90 cm
-  **ACCESSORIES:**  
Carbon filter
-  **EFFICIENCY:**  
280 m3/h



**BASIC**

















**SL-BOX GLASS**

**SL-BOX ROTARY**

**SL-BOX STRIPE**

-  **FINISH PAINTED+:**  
Black glass / White glass / Inox
-  **CONTROLS:**  
Push - push
-  **LIGHTING:**  
2 x 3 W GU10 LED Spot
-  **GREASE FILTER:**  
Aluminium
-  **AIR OUTLET:**  
150 mm
-  **WIDTH:**  
50 / 60 / 72 cm
-  **ACCESSORIES:**  
Carbon filter
-  **EFFICIENCY:**  
280 m3/h

-  **FINISH:**  
Black glass / White glass / Inox
-  **CONTROLS:**  
Mechanical - rotary knob
-  **LIGHTING:**  
2 x 3 W GU10 LED Spot
-  **GREASE FILTER:**  
Aluminium
-  **AIR OUTLET:**  
150 mm
-  **WIDTH:**  
60 / 72 cm
-  **ACCESSORIES:**  
Carbon filter
-  **EFFICIENCY:**  
330 m3/h

-  **FINISH:**  
Black / White / Inox
-  **CONTROLS:**  
Push - push
-  **LIGHTING:**  
1x 7 W LED Stripe
-  **GREASE FILTER:**  
Aluminium
-  **AIR OUTLET:**  
150 mm
-  **WIDTH:**  
60 / 72 cm
-  **ACCESSORIES:**  
Carbon filter
-  **EFFICIENCY:**  
330 m3/h

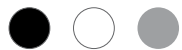

**BASIC**

**BASIC**

**BASIC**







**BUILT-IN HOODS**













**S-BOX**

**F-BOX I**

**F-BOX II**

-  **FINISH:**  
Black glass / White glass
-  **CONTROLS:**  
Push - push
-  **LIGHTING:**  
2 x 3 W LED Stripe
-  **GREASE FILTER:**  
Aluminium
-  **AIR OUTLET:**  
150 mm
-  **WIDTH:**  
55 cm
-  **ACCESSORIES:**  
Carbon filter
-  **EFFICIENCY:**  
330 m3/h

-  **FINISH:**  
Black glass / White glass
-  **CONTROLS:**  
Push - push
-  **LIGHTING:**  
1 x 7 W LED Stripe
-  **GREASE FILTER:**  
Aluminium
-  **AIR OUTLET:**  
150 mm
-  **WIDTH:**  
55 cm
-  **ACCESSORIES:**  
Carbon filter
-  **EFFICIENCY:**  
440 m3/h

-  **FINISH:**  
Black glass / White glass
-  **CONTROLS:**  
Push - push
-  **LIGHTING:**  
2 x 3 W LED Stripe
-  **GREASE FILTER:**  
Aluminium
-  **AIR OUTLET:**  
150 mm
-  **WIDTH:**  
55 cm
-  **ACCESSORIES:**  
Carbon filter
-  **EFFICIENCY:**  
440 m3/h











**BASIC**

**BASIC**

**BASIC**



### F-BOX III





-  **FINISH:**  
Black glass / White glass or painted
-  **CONTROLS:**  
Push - push
-  **LIGHTING:**  
1 x 7 W LED Stripe
-  **GREASE FILTER:**  
Aluminium
-  **AIR OUTLET:**  
150 mm
-  **WIDTH:**  
55 cm
-  **ACCESSORIES:**  
Carbon filter
-  **EFFICIENCY:**  
440 m3/h



**BASIC**



### F-BOX IV





-  **FINISH:**  
Black glass / White glass
-  **CONTROLS:**  
Push - push
-  **LIGHTING:**  
1 x 7 W LED Stripe
-  **GREASE FILTER:**  
Aluminium
-  **AIR OUTLET:**  
150 mm
-  **WIDTH:**  
55 cm
-  **ACCESSORIES:**  
Carbon filter
-  **EFFICIENCY:**  
440 m3/h



**BASIC**



### S-BOX FLEX ECO









-  **FINISH:**  
Black / White
-  **CONTROLS:**  
Push - push
-  **LIGHTING:**  
1 x 3 W GU10 LED Stripe
-  **GREASE FILTER:**  
Aluminium
-  **AIR OUTLET:**  
150 mm
-  **WIDTH:**  
60
-  **ACCESSORIES:**  
Carbon filter
-  **EFFICIENCY:**  
620 m3/h



**BASIC**



**S-BOX FLEX**







-  **FINISH:**  
Black / White + glass
-  **CONTROLS:**  
Push - push
-  **LIGHTING:**  
2 x 3 W GU10 LED Spot
-  **GREASE FILTER:**  
Aluminium
-  **AIR OUTLET:**  
150 mm
-  **WIDTH:**  
60 cm
-  **ACCESSORIES:**  
Carbon filter
-  **EFFICIENCY:**  
620 m3/h



**BASIC**



**LM-BOX**

-  **FINISH:**  
Black glass / White glass
-  **CONTROLS:**  
Push - push
-  **LIGHTING:**  
2 x 3 W GU10 LED Spot
-  **GREASE FILTER:**  
Aluminium
-  **AIR OUTLET:**  
150 mm
-  **WIDTH:**  
60 cm
-  **ACCESSORIES:**  
Carbon filter
-  **EFFICIENCY:**  
620 m3/h



**BASIC**



**SL-BOX EL**

-  **FINISH:**  
Black glass / White glass / Inox
-  **CONTROLS:**  
Soft touch
-  **LIGHTING:**  
1 x 12 W LED Stripe
-  **GREASE FILTER:**  
Aluminium
-  **AIR OUTLET:**  
150 mm
-  **WIDTH:**  
60 / 90 cm
-  **ACCESSORIES:**  
Carbon filter, Long Life Filter,  
Remote control
-  **EFFICIENCY:**  
650 m3/h



**COMFORT**



### CASO

-  **FINISH:**  
Black / Inox
-  **CONTROLS:**  
Soft touch
-  **LIGHTING:**  
2 x 3 W GU10 LED Spot
-  **GREASE FILTER:**  
Aluminium
-  **AIR OUTLET:**  
150 mm
-  **WIDTH:**  
50 / 60 / 72 cm
-  **ACCESORIES:**  
Carbon filter, Long Life Filter,  
Remote control
-  **EFFICIENCY:**  
650 m3/h



**COMFORT**



### MS BOX STRIPE









-  **FINISH:**  
Black / White / Inox
-  **CONTROLS:**  
Soft touch
-  **LIGHTING:**  
1 x 7 W LED Stripe
-  **GREASE FILTER:**  
Aluminium
-  **AIR OUTLET:**  
150 mm
-  **WIDTH:**  
60 / 72 cm
-  **ACCESORIES:**  
Carbon filter, Long Life Filter,  
Remote control
-  **EFFICIENCY:**  
650 m3/h



**COMFORT**



### MS BOX STRIPE

-  **FINISH PAINTED+:**  
Black glass / White glass / Inox
-  **CONTROLS:**  
Soft touch
-  **LIGHTING:**  
1 x 7 W LED Stripe
-  **GREASE FILTER:**  
Aluminium
-  **AIR OUTLET:**  
150 mm
-  **WIDTH:**  
54 / 72 cm
-  **ACCESORIES:**  
Carbon filter, Long Life Filter,  
Remote control
-  **EFFICIENCY:**  
650 m3/h



**COMFORT**



**MS BOX GLASS**

-  **FINISH PAINTED+:**  
Black glass / White glass / Inox
-  **CONTROLS:**  
Soft touch
-  **LIGHTING:**  
2 x 3 W LED Stripe
-  **GREASE FILTER:**  
Aluminium
-  **AIR OUTLET:**  
150 mm
-  **WIDTH:**  
54 / 72 cm
-  **ACCESORIES:**  
Carbon filter, Long Life Filter,  
Remote control
-  **EFFICIENCY:**  
650 m3/h



**COMFORT**



**S-BOX FLEX TOUCH**







-  **FINISH PAINTED+:**  
Black / White + glass
-  **CONTROLS:**  
Touch control
-  **LIGHTING:**  
2 x 3 W LED Stripe
-  **GREASE FILTER:**  
Aluminium
-  **AIR OUTLET:**  
150 mm
-  **WIDTH:**  
60 cm
-  **ACCESORIES:**  
Carbon filter, Long Life Filter,  
Decorative filter
-  **EFFICIENCY:**  
650 m3/h



**COMFORT**



**SL-T BOX**







-  **FINISH PAINTED+:**  
Black glass / White glass
-  **CONTROLS:**  
Touch control
-  **LIGHTING:**  
1 x 7 W LED Stripe
-  **GREASE FILTER:**  
Aluminium
-  **AIR OUTLET:**  
150 mm
-  **WIDTH:**  
60 cm
-  **ACCESORIES:**  
Carbon filter, Long Life Filter,  
Remote control
-  **EFFICIENCY:**  
650 m3/h



**COMFORT**



### SL BOX STRIPE EL







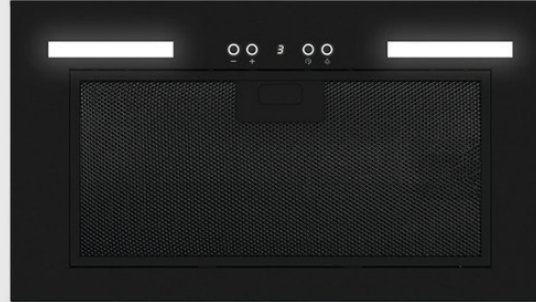

-  **FINISH:**  
Black / White painted, inox
-  **CONTROLS:**  
Soft touch
-  **LIGHTING:**  
1 x 6 W LED Stripe
-  **GREASE FILTER:**  
Aluminium
-  **AIR OUTLET:**  
150 mm
-  **WIDTH:**  
60 / 90 cm
-  **ACCESSORIES:**  
Carbon filter
-  **EFFICIENCY:**  
630 m3/h



**COMFORT**



### SL BOX 52 CM

-  **FINISH:**  
Black / White
-  **CONTROLS:**  
Round soft touch
-  **LIGHTING:**  
2 x 3 W LED Stripe
-  **GREASE FILTER:**  
Aluminium
-  **AIR OUTLET:**  
150 mm
-  **WIDTH:**  
52 cm
-  **ACCESSORIES:**  
Carbon filter
-  **EFFICIENCY:**  
630 m3/h



**COMFORT**

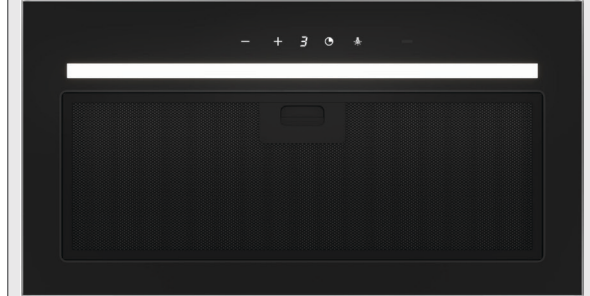

### G-BOX STRIPE









-  **FINISH PAINTED+:**  
Black / White glass
-  **CONTROLS:**  
Touch control
-  **LIGHTING:**  
1 x 6 W LED Stripe
-  **GREASE FILTER:**  
Aluminium
-  **AIR OUTLET:**  
150 mm
-  **WIDTH:**  
55cm
-  **ACCESSORIES:**  
Carbon filter
-  **EFFICIENCY:**  
630 m3/h



**COMFORT**



**S-BOX GESTURE**









-  **FINISH:**  
Black / White glass
-  **CONTROLS:**  
Gesture control + Remote control
-  **LIGHTING:**  
2 x 3 W LED Stripe
-  **GREASE FILTER:**  
Aluminium
-  **AIR OUTLET:**  
150 mm
-  **WIDTH:**  
55 / 74 cm
-  **ACCESORIES:**  
Carbon filter, Remote control
-  **EFFICIENCY:**  
630 m3/h



**PREMIUM**



**AERO SEAL**









-  **FINISH:**  
Black / Inox
-  **CONTROLS:**  
Soft touch
-  **LIGHTING:**  
2 x 3 W LED Stripe
-  **GREASE FILTER:**  
Baffle filter
-  **AIR OUTLET:**  
150 mm
-  **WIDTH:**  
45 / 60 / 90 cm
-  **ACCESORIES:**  
Carbon filter
-  **EFFICIENCY:**  
650 m3/h



**PREMIUM**



**S-BOX GESTURE V.2**

-  **FINISH:**  
Black / White glass
-  **CONTROLS:**  
Gesture control + Remote control
-  **LIGHTING:**  
2 x 3 W LED Stripe
-  **GREASE FILTER:**  
Aluminium
-  **AIR OUTLET:**  
150 mm
-  **WIDTH:**  
55 cm
-  **ACCESORIES:**  
Carbon filter
-  **EFFICIENCY:**  
720 m3/h



**PREMIUM**



### G-BOX

 **FINISH:**  
Black glass / White glass

 **CONTROLS:**  
Touch control

 **LIGHTING:**  
1 x 7 LED Stripe

 **GREASE FILTER:**  
Aluminium

 **AIR OUTLET:**  
150 mm

 **WIDTH:**  
55 / 74 cm

 **ACCESORIES:**  
Carbon filter, Long Life Filter,  
Remote Control

 **EFFICIENCY:**  
650 m3/h



**PREMIUM**



### G-BOX STRIPES

 **FINISH:**  
Black glass / White glass

 **CONTROLS:**  
Touch control

 **LIGHTING:**  
2 x 3 W LED Stripe

 **GREASE FILTER:**  
Aluminium

 **AIR OUTLET:**  
150 mm

 **WIDTH:**  
60 / 74 cm

 **ACCESORIES:**  
Carbon filter, Long Life Filter,  
Remote Control

 **EFFICIENCY:**  
650 m3/h



**PREMIUM**

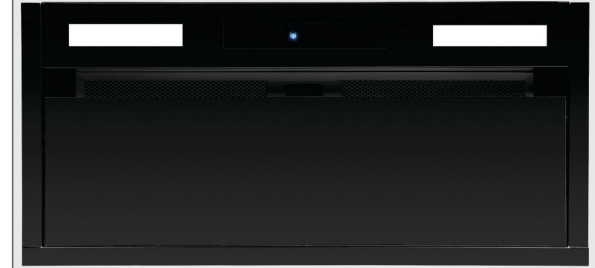

### GC-BOX

 **FINISH PAINTED+:**  
Black glass / White glass

 **CONTROLS:**  
Gesture Control + Remote control

 **LIGHTING:**  
2 x 3 W LED Stripe

 **GREASE FILTER:**  
Aluminium

 **AIR OUTLET:**  
150 mm

 **WIDTH:**  
60 / 90 cm

 **ACCESORIES:**  
Carbon filter, Long Life Filter

 **EFFICIENCY:**  
650 m3/h











**PREMIUM**







**GT-BOX**

**SU-BOX**

**WK**

-  **FINISH:**  
Black glass / White glass
-  **CONTROLS:**  
Touch control
-  **LIGHTING:**  
2 x 3 W LED Stripe
-  **GREASE FILTER:**  
Aluminium
-  **AIR OUTLET:**  
150 mm
-  **WIDTH:**  
60 / 74 cm
-  **ACCESORIES:**  
Carbon filter, Long life Filter, Remote control
-  **EFFICIENCY:**  
650 m3/h

-  **FINISH PAINTED+:**  
Black glass / White glass / Inox
-  **CONTROLS:**  
Touch control
-  **LIGHTING:**  
2 x 3 W LED Spot
-  **GREASE FILTER:**  
Aluminium
-  **AIR OUTLET:**  
150 mm
-  **WIDTH:**  
60 / 80 cm
-  **ACCESORIES:**  
Carbon filter, Long life Filter, Remote control
-  **EFFICIENCY:**  
650 m3/h

-  **FINISH:**  
Black / White / Inox
-  **CONTROLS:**  
Soft touch
-  **LIGHTING:**  
2 x 3 W LED Stripe
-  **GREASE FILTER:**  
Aluminium
-  **AIR OUTLET:**  
150 mm
-  **WIDTH:**  
60 / 90 cm
-  **ACCESORIES:**  
Carbon filter, Long life Filter, Remote control
-  **EFFICIENCY:**  
650 m3/h











**PREMIUM**

**PREMIUM**

**PREMIUM**



## SU FRAME MINI

-  **FINISH:**  
Black / White / Inox
-  **CONTROLS:**  
Remote control
-  **LIGHTING:**  
1 x LED Square
-  **GREASE FILTER:**  
Aluminium
-  **AIR OUTLET:**  
150 mm
-  **WIDTH:**  
90 /120 cm
-  **ACCESSORIES:**  
Long Life Filter, Remote Control
-  **EFFICIENCY:**  
700 m3/h



**PREMIUM**



# PULL-OUT HOODS

Hidden but effective!











41.

**PULL-OUT HOODS**



**SL-S FLAT**







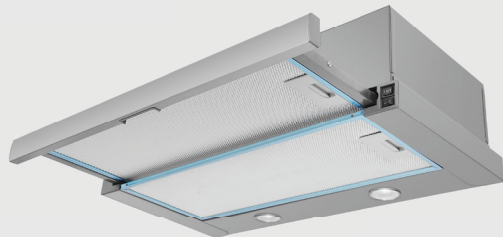

-  **FINISH:**  
Black / White / Inox
-  **CONTROLS:**  
Rocker switch
-  **LIGHTING:**  
1x Candle LED
-  **GREASE FILTER:**  
Aluminium
-  **AIR OUTLET:**  
120 / 150 mm
-  **WIDTH:**  
50 / 60 cm
-  **ACCESSORIES:**  
Carbon filter
-  **EFFICIENCY:**  
190 m3/h



**BASIC**



**SL-S**







-  **FINISH:**  
Black / White / Inox
-  **CONTROLS:**  
Rocker switch
-  **LIGHTING:**  
2 x 3 W GU10 LED Spot
-  **GREASE FILTER:**  
Aluminium
-  **AIR OUTLET:**  
120 / 150 mm
-  **WIDTH:**  
50 / 60 / 70 cm
-  **ACCESSORIES:**  
Carbon filter
-  **EFFICIENCY:**  
280 m3/h



**BASIC**



**SL-S ECO STRIPE**







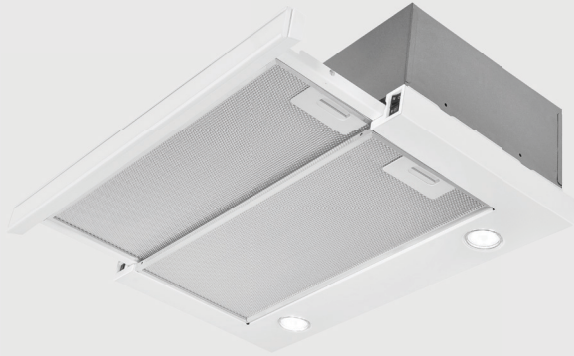

-  **FINISH:**  
Black / White / Inox
-  **CONTROLS:**  
Rocker switch
-  **LIGHTING:**  
1x 3 W LED Stripe
-  **GREASE FILTER:**  
Aluminium
-  **AIR OUTLET:**  
120 / 150 mm
-  **WIDTH:**  
50 / 60 cm
-  **ACCESSORIES:**  
Carbon filter
-  **EFFICIENCY:**  
280 m3/h



**BASIC**



### SL-SG







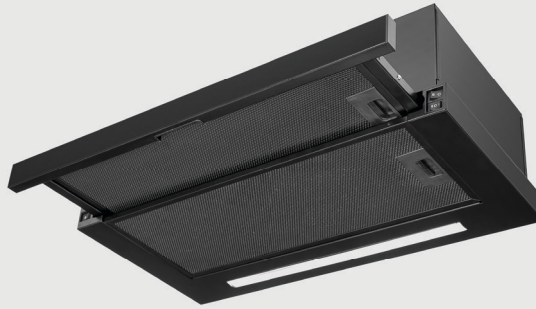

-  **FINISH:**  
Black glass / White glass
-  **CONTROLS:**  
Rocker switch
-  **LIGHTING:**  
2 x 3 W GU10 LED Spot
-  **GREASE FILTER:**  
Aluminium
-  **AIR OUTLET:**  
120 / 150 mm
-  **WIDTH:**  
50 / 60 cm
-  **ACCESSORIES:**  
Carbon filter
-  **EFFICIENCY:**  
330 m3/h



**BASIC**



### SL-SG STRIPE









-  **FINISH:**  
Black / White
-  **CONTROLS:**  
Rocker switch
-  **LIGHTING:**  
1 x 7 W LED Stripe
-  **GREASE FILTER:**  
Aluminium
-  **AIR OUTLET:**  
150 mm
-  **WIDTH:**  
50 / 60 cm
-  **ACCESSORIES:**  
Carbon filter
-  **EFFICIENCY:**  
330 m3/h



**BASIC**



### SL-NT

-  **FINISH:**  
Black + glass / White + glass
-  **CONTROLS:**  
Rocker switch
-  **LIGHTING:**  
1 x 7 W LED Stripe
-  **GREASE FILTER:**  
Aluminium
-  **AIR OUTLET:**  
150 mm
-  **WIDTH:**  
50 / 60 cm
-  **ACCESSORIES:**  
Carbon filter
-  **EFFICIENCY:**  
440 m3/h









**BASIC**

**PULL-OUT HOODS**



**SL-S STRIPE**









-  **FINISH:**  
Black / White / Inox
-  **CONTROLS:**  
Soft touch
-  **LIGHTING:**  
1 x 5 W LED Stripe
-  **GREASE FILTER:**  
Aluminium
-  **AIR OUTLET:**  
150 mm
-  **WIDTH:**  
60 cm
-  **ACCESSORIES:**  
Carbon filter
-  **EFFICIENCY:**  
665 m3/h



**COMFORT**



**SL-T**







-  **FINISH:**  
Black glass / White glass
-  **CONTROLS:**  
Touch control
-  **LIGHTING:**  
2 x 3 W GU10 LED Spot
-  **GREASE FILTER:**  
Aluminium
-  **AIR OUTLET:**  
150 mm
-  **WIDTH:**  
60 cm
-  **ACCESSORIES:**  
Carbon filter
-  **EFFICIENCY:**  
330 m3/h



**COMFORT**



**SL-SD**



-  **FINISH:**  
Black / White / Inox
-  **CONTROLS:**  
Electronic push - push
-  **LIGHTING:**  
1 x 7 W LED Stripe
-  **GREASE FILTER:**  
Aluminium
-  **AIR OUTLET:**  
150 mm
-  **WIDTH:**  
60 / 90 cm
-  **ACCESSORIES:**  
Carbon filter
-  **EFFICIENCY:**  
650 m3/h



**COMFORT**



### SL-TD ME









-  **FINISH:**  
Black glass / White glass / Inox
-  **CONTROLS:**  
Touch control
-  **LIGHTING:**  
2 x 3 W LED Stripe
-  **GREASE FILTER:**  
Aluminium
-  **AIR OUTLET:**  
150 mm
-  **WIDTH:**  
60 / 90 cm
-  **ACCESORIES:**  
Carbon filter, Long Life Filter
-  **EFFICIENCY:**  
650 m3/h



**PREMIUM**



### SLIDER

-  **FINISH:**  
Black glass / White glass
-  **CONTROLS:**  
Touch control
-  **LIGHTING:**  
1 x 7 W LED Stripe
-  **GREASE FILTER:**  
Decorative
-  **AIR OUTLET:**  
150 mm
-  **WIDTH:**  
60 / 90 cm
-  **ACCESORIES:**  
Carbon filter, Long Life Filter
-  **EFFICIENCY:**  
650 m3/h



**PREMIUM**



### SL PION

-  **FINISH:**  
Black / White / Inox
-  **CONTROLS:**  
Electronic push - push
-  **LIGHTING:**  
2 x 3 W GU10 LED Spot
-  **GREASE FILTER:**  
Aluminium
-  **AIR OUTLET:**  
150 mm
-  **WIDTH:**  
60 / 90 cm
-  **ACCESORIES:**  
Carbon filter, Long Life Filter
-  **EFFICIENCY:**  
650 m3/h



**PREMIUM**



# BUILD-UNDER HOODS

Simple but not simple!











47.

**BUILD-UNDER HOODS**



**ZRC SLIM**









-  **FINISH:**  
Black / White / Inox
-  **CONTROLS:**  
Mechanical slider
-  **LIGHTING:**  
1 x 7 W Candle LED bulb
-  **GREASE FILTER:**  
Aluminium
-  **AIR OUTLET:**  
120 mm
-  **WIDTH:**  
50 / 60 cm
-  **ACCESSORIES:**  
Carbon filter
-  **EFFICIENCY:**  
190 m3/h



**BASIC**



**ZR**









-  **FINISH:**  
Black / White / Inox
-  **CONTROLS:**  
Push - push
-  **LIGHTING:**  
1 x 7 W Candle LED bulb
-  **GREASE FILTER:**  
Aluminium
-  **AIR OUTLET:**  
120 mm
-  **WIDTH:**  
50 / 60 / 70 / 80 / 90 cm
-  **ACCESSORIES:**  
Carbon filter
-  **EFFICIENCY:**  
190 m3/h



**BASIC**



**ZQ**

-  **FINISH:**  
Black / White / Inox
-  **CONTROLS:**  
Push - push
-  **LIGHTING:**  
2 x 3 W GU10 LED Spot
-  **GREASE FILTER:**  
Aluminium
-  **AIR OUTLET:**  
120 mm
-  **WIDTH:**  
50 / 60 cm
-  **ACCESSORIES:**  
Carbon filter
-  **EFFICIENCY:**  
190 m3/h











**BASIC**



















**ZZC SLIM**

**ZZC**

**ZZS (TOUCH)**

-  **FINISH:**  
Black / White / Inox
-  **CONTROLS:**  
Mechanical slider
-  **LIGHTING:**  
1 x 7 W Candle LED bulb
-  **GREASE FILTER:**  
Aluminium
-  **AIR OUTLET:**  
120 mm
-  **WIDTH:**  
50 / 60 cm
-  **ACCESSORIES:**  
Carbon filter
-  **EFFICIENCY:**  
190 m3/h

-  **FINISH:**  
Black / White / Inox
-  **CONTROLS:**  
Push - push
-  **LIGHTING:**  
LED x2
-  **GREASE FILTER:**  
Aluminium
-  **AIR OUTLET:**  
120 mm
-  **WIDTH:**  
50 / 60 / 90 cm
-  **ACCESSORIES:**  
Carbon filter
-  **EFFICIENCY:**  
280 m3/h (2x motor)

-  **FINISH:**  
Black / White
-  **CONTROLS:**  
Touch control
-  **LIGHTING:**  
1 x 7 W LED Stripe
-  **GREASE FILTER:**  
Aluminium
-  **AIR OUTLET:**  
150 mm
-  **WIDTH:**  
60 cm
-  **ACCESSORIES:**  
Carbon filter
-  **EFFICIENCY:**  
280 m3/h (2x motor)



**BASIC**

**BASIC**

**COMFORT**





# CHIMNEY HOODS







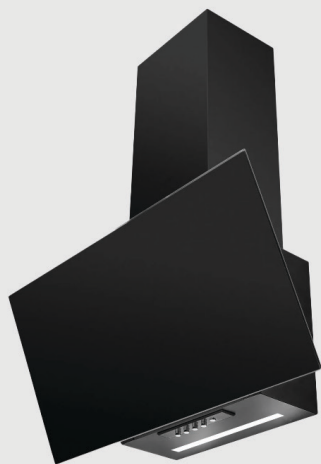

51. ■

# CHIMNEY HOODS



**JTS ECO**





-  **FINISH:**  
Black glass / White glass
-  **CONTROLS:**  
Push - push
-  **LIGHTING:**  
1 x 3 W LED Strip
-  **GREASE FILTER:**  
Aluminium
-  **AIR OUTLET:**  
150 mm
-  **WIDTH:**  
50 / 60 cm
-  **ACCESSORIES:**  
Carbon filter
-  **EFFICIENCY:**  
280 m3/h



**BASIC**



**JTS ECO II**



-  **FINISH:**  
Black glass / White glass
-  **CONTROLS:**  
Push - push
-  **LIGHTING:**  
2 x 3 W GU10 LED Spot
-  **GREASE FILTER:**  
Aluminium
-  **AIR OUTLET:**  
150 mm
-  **WIDTH:**  
50 / 60 / 90 cm
-  **ACCESSORIES:**  
Carbon filter
-  **EFFICIENCY:**  
280 m3/h



**BASIC**



**JTS ECO SA**

-  **FINISH:**  
Black glass / White glass
-  **CONTROLS:**  
Push - push
-  **LIGHTING:**  
2 x 3 W GU10 LED Spot
-  **GREASE FILTER:**  
Aluminium
-  **AIR OUTLET:**  
150 mm
-  **WIDTH:**  
50 / 60 / 90 cm
-  **ACCESSORIES:**  
Carbon filter
-  **EFFICIENCY:**  
280 m3/h



**BASIC**

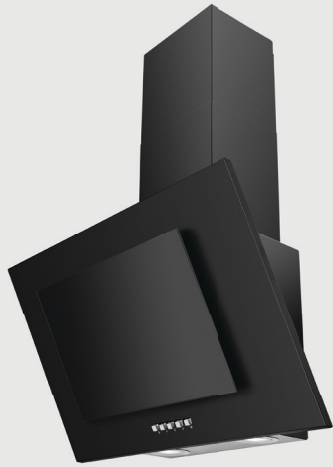

**NTI**





-  **FINISH:**  
Black glass / White glass / Inox
-  **CONTROLS:**  
Push - push
-  **LIGHTING:**  
2 x 3 W GU10 LED Spot
-  **GREASE FILTER:**  
Aluminium
-  **AIR OUTLET:**  
150 mm
-  **WIDTH:**  
50 / 60 cm
-  **ACCESSORIES:**  
Carbon filter
-  **EFFICIENCY:**  
330 m3/h

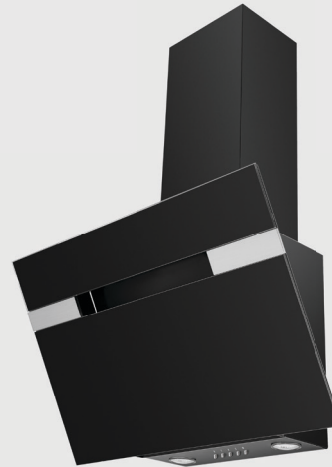

**BASIC**



**SA MINI**







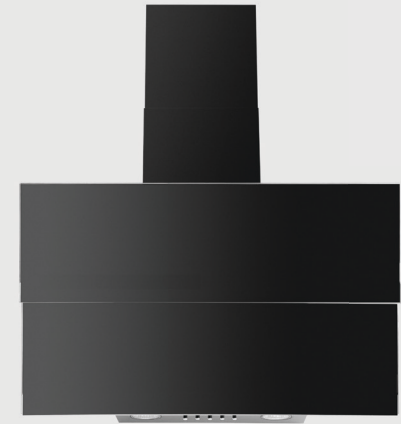

-  **FINISH:**  
Black glass / White glass
-  **CONTROLS:**  
Push - push
-  **LIGHTING:**  
2 x 3 W GU10 LED Spot
-  **GREASE FILTER:**  
Aluminium
-  **AIR OUTLET:**  
150 mm
-  **WIDTH:**  
60 / 90 cm
-  **ACCESSORIES:**  
Carbon filter
-  **EFFICIENCY:**  
440 m3/h



**BASIC**



**SCG**

-  **FINISH:**  
Black glass / White glass
-  **CONTROLS:**  
Push - push
-  **LIGHTING:**  
2 x 3 W GU10 LED Spot
-  **GREASE FILTER:**  
Aluminium
-  **AIR OUTLET:**  
150 mm
-  **WIDTH:**  
60 cm
-  **ACCESSORIES:**  
Carbon filter
-  **EFFICIENCY:**  
280 m3/h







**BASIC**

# CHIMNEY HOODS



**SCG IV**

-  **FINISH:**  
Black glass / White glass / Inox
-  **CONTROLS:**  
Push - push
-  **LIGHTING:**  
2 x 3 W GU10 LED Spot
-  **GREASE FILTER:**  
Aluminium
-  **AIR OUTLET:**  
150 mm
-  **WIDTH:**  
50 / 60 cm
-  **ACCESORIES:**  
Carbon filter
-  **EFFICIENCY:**  
280 m3/h



**BASIC**



**MWM**









-  **FINISH:**  
Black / Inox
-  **CONTROLS:**  
Push - push
-  **LIGHTING:**  
2 x 3 W GU10 LED Spot
-  **GREASE FILTER:**  
Aluminium
-  **AIR OUTLET:**  
150 mm
-  **WIDTH:**  
60 cm
-  **ACCESORIES:**  
Carbon filter
-  **EFFICIENCY:**  
330 m3/h



**BASIC**



**NT**

-  **FINISH:**  
Black / White glass+ painted stripe
-  **CONTROLS:**  
Push - push
-  **LIGHTING:**  
2 x 3 W GU10 LED Spot
-  **GREASE FILTER:**  
Aluminium
-  **AIR OUTLET:**  
120 / 150 mm
-  **WIDTH:**  
60 cm
-  **ACCESORIES:**  
Carbon filter,
-  **EFFICIENCY:**  
320 m3/h



**BASIC**



**DIAMOND MINI**







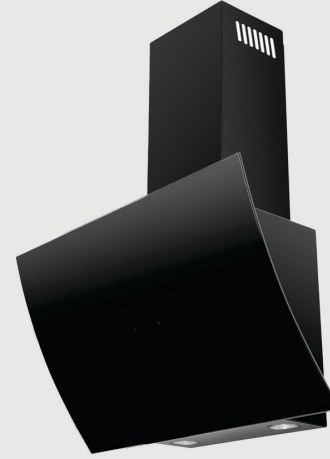

-  **FINISH:**  
Black glass / White glass / Inox
-  **CONTROLS:**  
Touch control
-  **LIGHTING:**  
2 x 3 W LED Spot
-  **GREASE FILTER:**  
Aluminium
-  **AIR OUTLET:**  
150 mm
-  **WIDTH:**  
60 / 80 / 90 cm
-  **ACCESORIES:**  
Carbon filter, Long Life Filter
-  **EFFICIENCY:**  
620 m3/h



**COMFORT**



**SKO**

-  **FINISH:**  
Black glass / White glass
-  **CONTROLS:**  
Touch control
-  **LIGHTING:**  
2 x 3 W LED Spot
-  **GREASE FILTER:**  
Aluminium
-  **AIR OUTLET:**  
150 mm
-  **WIDTH:**  
60 / 90 cm
-  **ACCESORIES:**  
Carbon filter, Long Life Filter
-  **EFFICIENCY:**  
620 m3/h



**COMFORT**



**SKU**

-  **FINISH:**  
Black glass / White glass
-  **CONTROLS:**  
Touch control
-  **LIGHTING:**  
2 x 3 W LED Spot
-  **GREASE FILTER:**  
Aluminium
-  **AIR OUTLET:**  
150 mm
-  **WIDTH:**  
60 / 90 cm
-  **ACCESORIES:**  
Carbon filter, Long Life Filter
-  **EFFICIENCY:**  
620 m3/h





**COMFORT**

**CHIMNEY HOODS**











**DIAMOND EDGE**

-  **FINISH:**  
Black glass + painted ruffled stripe
-  **CONTROLS:**  
Touch control
-  **LIGHTING:**  
2 x 3 W LED Sptripe
-  **GREASE FILTER:**  
Aluminium
-  **AIR OUTLET:**  
150 mm
-  **WIDTH:**  
60 / 90 cm
-  **ACCESSORIES:**  
Carbon filter
-  **EFFICIENCY:**  
620 m3/h



**SA V II**

-  **FINISH:**  
Black glass + Inox elements
-  **CONTROLS:**  
Touch control
-  **LIGHTING:**  
2 x LED Spot
-  **GREASE FILTER:**  
Aluminium
-  **AIR OUTLET:**  
150 mm
-  **WIDTH:**  
60 / 80 cm
-  **ACCESSORIES:**  
Carbon filter
-  **EFFICIENCY:**  
330 m3/h



**NTF**

-  **FINISH:**  
Black glass / White glass
-  **CONTROLS:**  
Touch control
-  **LIGHTING:**  
2 x 3 W LED Spot
-  **GREASE FILTER:**  
Aluminium
-  **AIR OUTLET:**  
150 mm
-  **WIDTH:**  
60 / 90 cm
-  **ACCESSORIES:**  
Carbon filter, Long Life Filter
-  **EFFICIENCY:**  
440 m3/h



**COMFORT**





**COMFORT**



**COMFORT**



**MAT II**

-  **FINISH:**  
Black MAT + glass / Inox + glass
-  **CONTROLS:**  
Touch control
-  **LIGHTING:**  
2 x LED Stripe
-  **GREASE FILTER:**  
Aluminium
-  **AIR OUTLET:**  
150 mm
-  **WIDTH:**  
60 / 90 cm
-  **ACCESORIES:**  
Carbon filter
-  **EFFICIENCY:**  
620 m3/h



**COMFORT**



**MAT**

-  **FINISH:**  
Black - glass MAT
-  **CONTROLS:**  
Touch control
-  **LIGHTING:**  
1 x 7 W LED Stripe
-  **GREASE FILTER:**  
Aluminium
-  **AIR OUTLET:**  
150 mm
-  **WIDTH:**  
60 / 90 cm
-  **ACCESORIES:**  
Carbon filter, Long Life Filter,  
Remote control
-  **EFFICIENCY:**  
650 m3/h



**COMFORT**

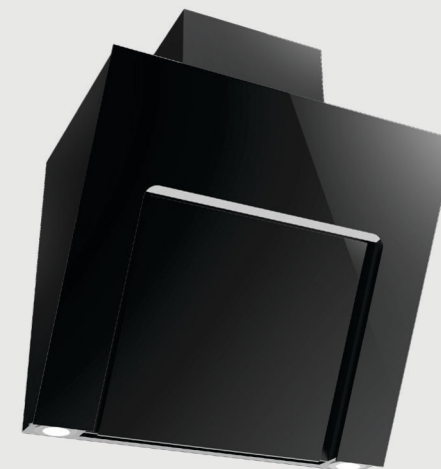

**SN LED**

-  **FINISH:**  
Black glass / White glass / Inox
-  **CONTROLS:**  
Touch control
-  **LIGHTING:**  
2 x 3 W LED Spot + 1 x 7 LED Stripe
-  **GREASE FILTER:**  
Aluminium
-  **AIR OUTLET:**  
150 mm
-  **WIDTH:**  
60 / 90 cm
-  **ACCESORIES:**  
Carbon filter, Long Life Filter
-  **EFFICIENCY:**  
650 m3/h



**COMFORT**

# CHIMNEY HOODS



**SB II**

-  **FINISH:**  
Black glass / White glass
-  **CONTROLS:**  
Touch control
-  **LIGHTING:**  
2 x 3 W LED Spot
-  **GREASE FILTER:**  
Aluminium
-  **AIR OUTLET:**  
150 mm
-  **WIDTH:**  
60 / 90 cm
-  **ACCESSORIES:**  
Carbon filter, Long Life Filter
-  **EFFICIENCY:**  
650 m3/h



**COMFORT**



**SN**









-  **FINISH:**  
Black glass / White glass / Inox
-  **CONTROLS:**  
Touch control
-  **LIGHTING:**  
2 x 3 W LED Spot
-  **GREASE FILTER:**  
Aluminium
-  **AIR OUTLET:**  
150 mm
-  **WIDTH:**  
60 / 90 cm
-  **ACCESSORIES:**  
Carbon filter, Long Life Filter
-  **EFFICIENCY:**  
650 m3/h



**COMFORT**



**JTS FRAME**

-  **FINISH:**  
Black glass with transparent frame
-  **CONTROLS:**  
Touch control
-  **LIGHTING:**  
1 x 7 W LED Stripe
-  **GREASE FILTER:**  
Aluminium
-  **AIR OUTLET:**  
150 mm
-  **WIDTH:**  
60 / 80 / 90 cm
-  **ACCESSORIES:**  
Carbon filter, Long Life Filter
-  **EFFICIENCY:**  
620 m3/h



**PREMIUM**



### DIAMOND

 **FINISH:**  
Black glass / White glass

 **CONTROLS:**  
Touch control

 **LIGHTING:**  
2 x 3 W LED Spot

 **GREASE FILTER:**  
Aluminium

 **AIR OUTLET:**  
150 mm

 **WIDTH:**  
60 / 80 / 90 cm

 **ACCESORIES:**  
Carbon filter, Long Life Filter

 **EFFICIENCY:**  
650 m3/h



**PREMIUM**



### BLACK PEARL

 **FINISH:**  
Black glass / White glass / Inox

 **CONTROLS:**  
Touch control

 **LIGHTING:**  
2 x 3 W LED Spot

 **GREASE FILTER:**  
Aluminium

 **AIR OUTLET:**  
150 mm

 **WIDTH:**  
60 / 90 cm

 **ACCESORIES:**  
Carbon filter, Long Life Filter

 **EFFICIENCY:**  
650 m3/h



**PREMIUM**

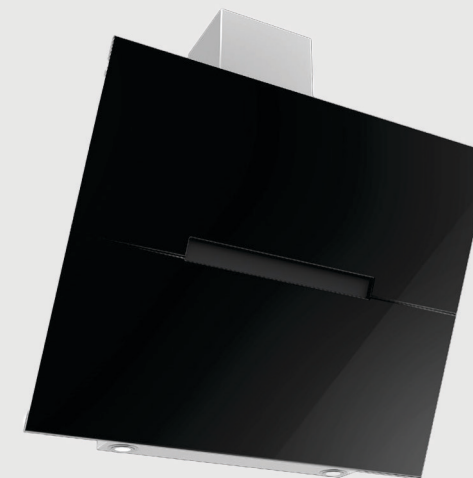

### NSA

 **FINISH:**  
Black glass / White glass

 **CONTROLS:**  
Touch control

 **LIGHTING:**  
2 x 3 W LED Stripe

 **GREASE FILTER:**  
Aluminium

 **AIR OUTLET:**  
150 mm

 **WIDTH:**  
60 / 90 cm

 **ACCESORIES:**  
Carbon filter, Long Life Filter

 **EFFICIENCY:**  
650 m3/h



**PREMIUM**

# CHIMNEY HOODS



**SA**

 **FINISH:**  
Black glass / White glass

 **CONTROLS:**  
Touch control

 **LIGHTING:**  
2 x 3 W LED Spot

 **GREASE FILTER:**  
Aluminium

 **AIR OUTLET:**  
150 mm

 **WIDTH:**  
60 / 90 cm

 **ACCESSORIES:**  
Carbon filter, Long Life Filter

 **EFFICIENCY:**  
650 m3/h



**PREMIUM**



**SDI**

 **FINISH:**  
Black / Inox

 **CONTROLS:**  
Soft touch

 **LIGHTING:**  
2 x 3 W LED Spot

 **GREASE FILTER:**  
Aluminium

 **AIR OUTLET:**  
150 mm

 **WIDTH:**  
60 / 80 / 90 cm

 **ACCESSORIES:**  
Carbon filter, Long Life Filter

 **EFFICIENCY:**  
650 m3/h



**PREMIUM**



**SA IV**

 **FINISH:**  
Black glass / White glass / Inox

 **CONTROLS:**  
Touch control

 **LIGHTING:**  
2 x 3 W LED Spot

 **GREASE FILTER:**  
Aluminium

 **AIR OUTLET:**  
150 mm

 **WIDTH:**  
60 / 80 / 90 cm

 **ACCESSORIES:**  
Carbon filter, Long Life Filter

 **EFFICIENCY:**  
650 m3/h



**PREMIUM**



**NKK**







-  **FINISH:**  
Black glass / White glass
-  **CONTROLS:**  
Touch control+Remote control
-  **LIGHTING:**  
2 x 3 W LED Stripe
-  **GREASE FILTER:**  
Aluminium
-  **AIR OUTLET:**  
150 mm
-  **WIDTH:**  
60 / 90 cm
-  **ACCESORIES:**  
Carbon filter, Long Life Filter
-  **EFFICIENCY:**  
650 m3/h



**PREMIUM**



**WKL**







-  **FINISH:**  
Black glass
-  **CONTROLS:**  
Touch control
-  **LIGHTING:**  
1 x 7 W LED Stripe
-  **GREASE FILTER:**  
Aluminium
-  **AIR OUTLET:**  
150 mm
-  **WIDTH:**  
60 / 90 cm
-  **ACCESORIES:**  
Carbon filter, Long Life Filter
-  **EFFICIENCY:**  
650 m3/h



**PREMIUM**



**ICARO**

-  **FINISH:**  
Black glass / White glass
-  **CONTROLS:**  
Touch control
-  **LIGHTING:**  
1 x 12 W LED Stripe
-  **GREASE FILTER:**  
Aluminium
-  **AIR OUTLET:**  
150 mm
-  **WIDTH:**  
60 / 90 cm
-  **ACCESORIES:**  
Carbon filter, Long Life Filter
-  **EFFICIENCY:**  
650 m3/h









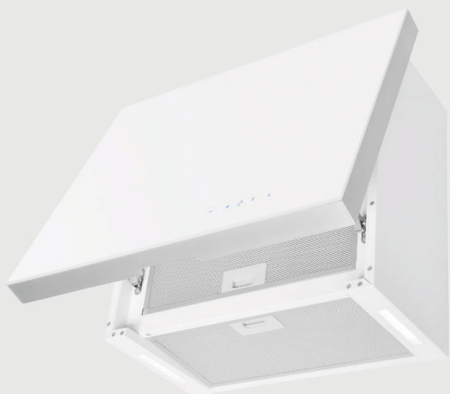

**PREMIUM**

**CHIMNEY HOODS**

# CHIMNEY HOODS



**POS**





-  **FINISH:**  
Black glass / White glass
-  **CONTROLS:**  
Touch control
-  **LIGHTING:**  
2 x 3 W LED Stripe
-  **GREASE FILTER:**  
Aluminium
-  **AIR OUTLET:**  
150 mm
-  **WIDTH:**  
60 / 90 cm
-  **ACCESSORIES:**  
Carbon filter, Long Life Filter
-  **EFFICIENCY:**  
650 m3/h

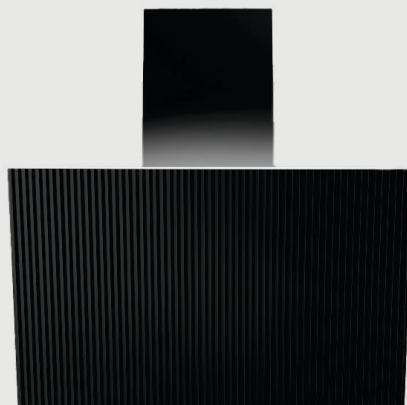

**PREMIUM**



**EVOLUTION**







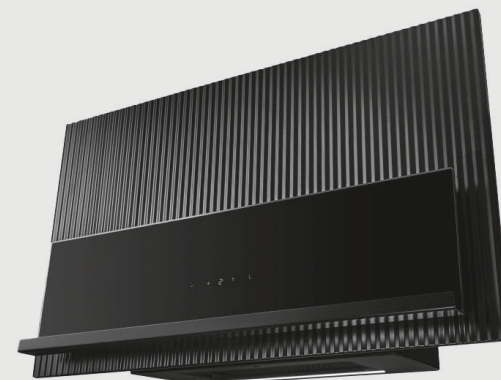

-  **FINISH:**  
Black / White / Gold
-  **CONTROLS:**  
Soft touch
-  **LIGHTING:**  
2 x 7 W LED Spot
-  **GREASE FILTER:**  
Aluminium
-  **AIR OUTLET:**  
150 mm
-  **WIDTH:**  
60 / 90 cm
-  **ACCESSORIES:**  
Carbon filter, Long Life Filter
-  **EFFICIENCY:**  
650 m3/h



**PREMIUM**



**TABVERTO**





-  **FINISH:**  
Black / White
-  **CONTROLS:**  
Touch control
-  **LIGHTING:**  
1 x 7 W LED Spot
-  **GREASE FILTER:**  
Aluminium
-  **AIR OUTLET:**  
150 mm
-  **WIDTH:**  
90 cm
-  **ACCESSORIES:**  
Carbon filter, Long Life Filter
-  **EFFICIENCY:**  
650 m3/h



**PREMIUM**



**CITRO X**









-  **FINISH:**  
Black / White
-  **CONTROLS:**  
Touch control
-  **LIGHTING:**  
2 x 3 W LED Spot
-  **GREASE FILTER:**  
Aluminium
-  **AIR OUTLET:**  
150 mm
-  **WIDTH:**  
60 / 90 cm
-  **ACCESORIES:**  
Carbon filter, Long Life Filter
-  **EFFICIENCY:**  
650 m3/h



**PREMIUM**



**SPECJAL**





-  **FINISH:**  
Black / White / Inox
-  **CONTROLS:**  
Push - push
-  **LIGHTING:**  
2 x 3 W GU10 LED Spot
-  **GREASE FILTER:**  
Aluminium
-  **AIR OUTLET:**  
150 mm
-  **WIDTH:**  
60 / 90 cm
-  **ACCESORIES:**  
Carbon filter
-  **EFFICIENCY:**  
330 m3/h



**BASIC**



**SIGMA**

-  **FINISH:**  
Black / White / Inox + Glass
-  **CONTROLS:**  
Push - push
-  **LIGHTING:**  
2 x 3 W GU10 LED Spot
-  **GREASE FILTER:**  
Aluminium
-  **AIR OUTLET:**  
150 mm
-  **WIDTH:**  
50 / 60 / 90 cm
-  **ACCESORIES:**  
Carbon filter
-  **EFFICIENCY:**  
330 m3/h







**BASIC**

# CHIMNEY HOODS



**RETRO**









-  **FINISH:**  
Black / White / Ivory
-  **CONTROLS:**  
Push - push
-  **LIGHTING:**  
2 x 3 W GU10 LED Spot
-  **GREASE FILTER:**  
Aluminium
-  **AIR OUTLET:**  
150 mm
-  **WIDTH:**  
60 / 90 cm
-  **ACCESSORIES:**  
Carbon filter
-  **EFFICIENCY:**  
330 m3/h



**BASIC**



**CRE**









-  **FINISH:**  
Black / White / Ivory + wooden frame
-  **CONTROLS:**  
Push - push
-  **LIGHTING:**  
2 x 3 W GU10 LED Spot
-  **GREASE FILTER:**  
Aluminium
-  **AIR OUTLET:**  
150 mm
-  **WIDTH:**  
60 / 90 cm
-  **ACCESSORIES:**  
Carbon filter
-  **EFFICIENCY:**  
440 m3/h



**BASIC**



**QUATRO QE**

-  **FINISH:**  
Black / White / Inox
-  **CONTROLS:**  
Push - push
-  **LIGHTING:**  
2 x candle bulb
-  **GREASE FILTER:**  
Aluminium
-  **AIR OUTLET:**  
150 mm
-  **WIDTH:**  
60 cm
-  **ACCESSORIES:**  
Carbon filter
-  **EFFICIENCY:**  
280 m3/h











**BASIC**

















### QUATRO

### QUATRO E STRIPE

### T-SHAPE ROTARY

-  **FINISH:**  
Black / White / Inox
-  **CONTROLS:**  
Push - push
-  **LIGHTING:**  
2 x 3 W LED Spot
-  **GREASE FILTER:**  
Aluminium
-  **AIR OUTLET:**  
150 mm
-  **WIDTH:**  
60 / 90 cm
-  **ACCESORIES:**  
Carbon filter
-  **EFFICIENCY:**  
330 m3/h

-  **FINISH:**  
Black / White / Inox
-  **CONTROLS:**  
Push - push
-  **LIGHTING:**  
1 x 7 W LED Stripe
-  **GREASE FILTER:**  
Aluminium
-  **AIR OUTLET:**  
150 mm
-  **WIDTH:**  
60 / 90 cm
-  **ACCESORIES:**  
Carbon filter, Long Life Filter
-  **EFFICIENCY:**  
440 m3/h

-  **FINISH:**  
Black / White
-  **CONTROLS:**  
Rotary knob
-  **LIGHTING:**  
1 x 7 W LED Stripe
-  **GREASE FILTER:**  
Aluminium
-  **AIR OUTLET:**  
150 mm
-  **WIDTH:**  
60 cm
-  **ACCESORIES:**  
Carbon filter
-  **EFFICIENCY:**  
650 m3/h



**BASIC**









**BASIC**

**BASIC**

**CHIMNEY HOODS**



**BLACK SLIM**

-  **FINISH:**  
Black
-  **CONTROLS:**  
Soft touch
-  **LIGHTING:**  
2 x LED Stripe
-  **GREASE FILTER:**  
Aluminium
-  **AIR OUTLET:**  
150 mm
-  **WIDTH:**  
60 / 70 / 80 / 90 / 100 / 110 / 120 cm
-  **ACCESSORIES:**  
Carbon filter
-  **EFFICIENCY:**  
650 m3/h



**COMFORT**



**BLACK SLIM STRIPE**









-  **FINISH PAINTED+:**  
Black + glass / White + glass
-  **CONTROLS:**  
Touch control
-  **LIGHTING:**  
1 x 7 W LED Stripe
-  **GREASE FILTER:**  
Aluminium
-  **AIR OUTLET:**  
150 mm
-  **WIDTH:**  
60 / 70 / 80 / 90 cm
-  **ACCESSORIES:**  
Carbon filter, Long Life Filter
-  **EFFICIENCY:**  
650 m3/h



**COMFORT**



**BLACK SLIM TOUCH**

-  **FINISH PAINTED+:**  
Black + glass / White + glass
-  **CONTROLS:**  
Touch control
-  **LIGHTING:**  
LED x2 Stripe
-  **GREASE FILTER:**  
Aluminium
-  **AIR OUTLET:**  
150 mm
-  **WIDTH:**  
60 / 90 cm
-  **ACCESSORIES:**  
Carbon filter, Long Life Filter
-  **EFFICIENCY:**  
650 m3/h



**COMFORT**



**QUATRO BLACK ROUND**

-  **FINISH INOX+:**  
Black glass / White glass / Inox
-  **CONTROLS:**  
Touch control
-  **LIGHTING:**  
2 x 3 W LED Stripe
-  **GREASE FILTER:**  
Aluminium
-  **AIR OUTLET:**  
150 mm
-  **WIDTH:**  
60 / 90 cm
-  **ACCESSORIES:**  
Carbon filter, Long Life Filter
-  **EFFICIENCY:**  
650 m3/h



**COMFORT**



**QUATRO BT**









-  **FINISH:**  
Black / White / Inox + glass
-  **CONTROLS:**  
Touch control
-  **LIGHTING:**  
2 x 3 W LED Spot
-  **GREASE FILTER:**  
Aluminium
-  **AIR OUTLET:**  
150 mm
-  **WIDTH:**  
60 / 90 cm
-  **ACCESSORIES:**  
Carbon filter, Long Life Filter
-  **EFFICIENCY:**  
650 m3/h



**COMFORT**



**QUATRO BLACK**

-  **FINISH:**  
Inox + black glass
-  **CONTROLS:**  
Touch control
-  **LIGHTING:**  
2 x 3 W GU10 LED Spot
-  **GREASE FILTER:**  
Aluminium
-  **AIR OUTLET:**  
150 mm
-  **WIDTH:**  
60 / 90 cm
-  **ACCESSORIES:**  
Carbon filter
-  **EFFICIENCY:**  
650 m3/h





**COMFORT**

# CHIMNEY HOODS



**QUATRO TOUCH**







-  **FINISH:**  
Black / White / Inox
-  **CONTROLS:**  
Soft touch
-  **LIGHTING:**  
2x 3 W LED Stripe
-  **GREASE FILTER:**  
Aluminium
-  **AIR OUTLET:**  
150 mm
-  **WIDTH:**  
60 / 70 / 80 / 90 / 100 / 110 / 120 cm
-  **ACCESORIES:**  
Carbon filter, Long Life Filter
-  **EFFICIENCY:**  
650 m3/h



**COMFORT**



**SIGMA TOUCH**

-  **FINISH:**  
Inox + glass
-  **CONTROLS:**  
Touch control
-  **LIGHTING:**  
2 x 3 W LED Spot
-  **GREASE FILTER:**  
Aluminium
-  **AIR OUTLET:**  
150 mm
-  **WIDTH:**  
60 / 90 cm
-  **ACCESORIES:**  
Carbon filter, Long Life Filter
-  **EFFICIENCY:**  
650 m3/h



**COMFORT**



**SIGMA E**

-  **FINISH:**  
Inox + glass
-  **CONTROLS:**  
Soft touch
-  **LIGHTING:**  
2 x 3 LED Spot
-  **GREASE FILTER:**  
Aluminium
-  **AIR OUTLET:**  
150 mm
-  **WIDTH:**  
50 / 60 / 90 cm
-  **ACCESORIES:**  
Carbon filter, Long Life Filter
-  **EFFICIENCY:**  
440 m3/h



**COMFORT**



### BLACK ZENTRO







-  **FINISH:**  
Black MAT + glass / Inox + glass
-  **CONTROLS:**  
Touch control
-  **LIGHTING:**  
2 x LED Stripe
-  **GREASE FILTER:**  
Aluminium
-  **AIR OUTLET:**  
150 mm
-  **WIDTH:**  
60 / 90 cm
-  **ACCESSORIES:**  
Carbon filter
-  **EFFICIENCY:**  
725 m3/h



**PREMIUM**



### T-STRIPE









-  **FINISH:**  
Black glass / Inox
-  **CONTROLS:**  
Gesture Control + Remote control
-  **LIGHTING:**  
1 x 7 W LED Stripe
-  **GREASE FILTER:**  
Aluminium
-  **AIR OUTLET:**  
150 mm
-  **WIDTH:**  
60 / 90 cm
-  **ACCESSORIES:**  
Carbon filter, Long Life Filter
-  **EFFICIENCY:**  
650 m3/h



**PREMIUM**



### T-LIGHT

-  **FINISH:**  
Black
-  **CONTROLS:**  
Gesture Control + Remote control
-  **LIGHTING:**  
1 x 10 W LED Panel
-  **GREASE FILTER:**  
Aluminium
-  **AIR OUTLET:**  
150 mm
-  **WIDTH:**  
60 / 90 cm
-  **ACCESSORIES:**  
Carbon filter, Long Life Filter
-  **EFFICIENCY:**  
650 m3/h



**PREMIUM**

# CHIMNEY HOODS



**ORP GLASS**









-  **FINISH:**  
Black glass / White / Inox + glass
-  **CONTROLS:**  
Touch control
-  **LIGHTING:**  
2 x 3 W LED Spot
-  **GREASE FILTER:**  
Aluminium
-  **AIR OUTLET:**  
150 mm
-  **WIDTH:**  
Ø 39 cm
-  **ACCESSORIES:**  
Carbon filter, Long Life Filter
-  **EFFICIENCY:**  
650 m3/h



**PREMIUM**



**KRP ECO**









-  **FINISH:**  
Black / White / Inox
-  **CONTROLS:**  
Push - push
-  **LIGHTING:**  
2 x 3 W LED Spot
-  **GREASE FILTER:**  
Aluminium
-  **AIR OUTLET:**  
150 mm
-  **WIDTH:**  
40 cm
-  **ACCESSORIES:**  
Carbon filter, Long Life Filter
-  **EFFICIENCY:**  
440 m3/h



**BASIC**



**KRP**









-  **FINISH:**  
Black / White / Inox
-  **CONTROLS:**  
Soft touch
-  **LIGHTING:**  
2 x 3 W LED Spot
-  **GREASE FILTER:**  
Aluminium
-  **AIR OUTLET:**  
150 mm
-  **WIDTH:**  
40 cm
-  **ACCESSORIES:**  
Carbon filter, Long Life Filter
-  **EFFICIENCY:**  
650 m3/h



**COMFORT**



**ORP MINI**









-  **FINISH:**  
Black / White
-  **CONTROLS:**  
Push - push
-  **LIGHTING:**  
2 x 2 W LED Spot
-  **GREASE FILTER:**  
Aluminium
-  **AIR OUTLET:**  
150 mm
-  **WIDTH:**  
Ø 32 cm
-  **ACCESSORIES:**  
Carbon filter
-  **EFFICIENCY:**  
330 m3/h



**BASIC**



**ORP ECO**









-  **FINISH:**  
Black / White / Inox
-  **CONTROLS:**  
Push - push
-  **LIGHTING:**  
2 x 2 W LED Spot
-  **GREASE FILTER:**  
Aluminium
-  **AIR OUTLET:**  
150 mm
-  **WIDTH:**  
Ø 39 cm
-  **ACCESSORIES:**  
Carbon filter
-  **EFFICIENCY:**  
440 m3/h



**BASIC**



**ORP**

-  **FINISH:**  
Black / White / Inox
-  **CONTROLS:**  
Soft touch
-  **LIGHTING:**  
2 x 3 LED Spot
-  **GREASE FILTER:**  
Aluminium
-  **AIR OUTLET:**  
150 mm
-  **WIDTH:**  
Ø 39 cm
-  **ACCESSORIES:**  
Carbon filter, Long Life Filter
-  **EFFICIENCY:**  
650 m3/h



**COMFORT**













# ISLAND HOODS



73. ■



**SIGMA W**









-  **FINISH:**  
Inox
-  **CONTROLS:**  
Soft touch
-  **LIGHTING:**  
4 x 3 W LED Spot
-  **GREASE FILTER:**  
Aluminium
-  **AIR OUTLET:**  
150 mm
-  **WIDTH:**  
90 x 60 cm
-  **ACCESSORIES:**  
Carbon filter
-  **EFFICIENCY:**  
440 m3/h



**BASIC**



**SIGMA W TOUCH**

-  **FINISH:**  
Inox
-  **CONTROLS:**  
Touch control
-  **LIGHTING:**  
4 x 3 W LED Spot
-  **GREASE FILTER:**  
Aluminium
-  **AIR OUTLET:**  
150 mm
-  **WIDTH:**  
90 x 60 cm
-  **ACCESSORIES:**  
Carbon filter
-  **EFFICIENCY:**  
650 m3/h



**COMFORT**



**BLACK SLIM W**

-  **FINISH PAINTED+:**  
Black glass / Inox + Black Glass
-  **CONTROLS:**  
Touch control
-  **LIGHTING:**  
4 x 3 W LED Spot
-  **GREASE FILTER:**  
Aluminium
-  **AIR OUTLET:**  
150 mm
-  **WIDTH:**  
90 x 60 cm
-  **ACCESSORIES:**  
Carbon filter, Long Life Filter
-  **EFFICIENCY:**  
650 m3/h





**COMFORT**

















### BLACK SLIM W STRIPE

### T-STRIPE W

### ORW ECO

-  **FINISH:**  
Black glass / Inox + Black Glass
-  **CONTROLS:**  
Touch control
-  **LIGHTING:**  
4 x 3 W LED Stripe
-  **GREASE FILTER:**  
Aluminium
-  **AIR OUTLET:**  
150 mm
-  **WIDTH:**  
90 x 60 cm
-  **ACCESSORIES:**  
Carbon filter, Long Life Filter
-  **EFFICIENCY:**  
650 m3/h

-  **FINISH:**  
Black glass, painted black
-  **CONTROLS:**  
Gesture Control + Remote control
-  **LIGHTING:**  
1 x 7 W LED Stripe
-  **GREASE FILTER:**  
Aluminium
-  **AIR OUTLET:**  
150 mm
-  **WIDTH:**  
90 x 60 cm
-  **ACCESSORIES:**  
Carbon filter, Long Life Filter
-  **EFFICIENCY:**  
650 m3/h

-  **FINISH:**  
Black / White / Inox
-  **CONTROLS:**  
Push - push
-  **LIGHTING:**  
2 x 2 LED Spot
-  **GREASE FILTER:**  
Aluminium
-  **AIR OUTLET:**  
150 mm
-  **WIDTH:**  
Ø 39 cm
-  **ACCESSORIES:**  
Carbon filter
-  **EFFICIENCY:**  
440 m3/h











**PREMIUM**

**PREMIUM**

**BASIC**



**ORW**

-  **FINISH:**  
Black / White / Inox
-  **CONTROLS:**  
Soft touch
-  **LIGHTING:**  
2 x 3 W LED Spot
-  **GREASE FILTER:**  
Aluminium
-  **AIR OUTLET:**  
150 mm
-  **WIDTH:**  
Ø 39 cm
-  **ACCESSORIES:**  
Carbon filter, Long Life Filter
-  **EFFICIENCY:**  
650 m3/h



**COMFORT**



**ORW GLASS**







-  **FINISH:**  
Black glass / White Glass / Inox
-  **CONTROLS:**  
Touch control
-  **LIGHTING:**  
4 x 3 W LED Spot
-  **GREASE FILTER:**  
Aluminium
-  **AIR OUTLET:**  
150 mm
-  **WIDTH:**  
Ø 39 cm
-  **ACCESSORIES:**  
Carbon filter, Long Life Filter
-  **EFFICIENCY:**  
650 m3/h



**PREMIUM**



**KRW ECO**



-  **FINISH:**  
Black / White / Inox
-  **CONTROLS:**  
Push - push
-  **LIGHTING:**  
2 x 3 W LED Spot
-  **GREASE FILTER:**  
Aluminium
-  **AIR OUTLET:**  
150 mm
-  **WIDTH:**  
40 x 30 cm
-  **ACCESSORIES:**  
Carbon filter
-  **EFFICIENCY:**  
440 m3/h



**BASIC**



**KRW**

-  **FINISH:**  
Black / White / Inox
-  **CONTROLS:**  
Soft touch
-  **LIGHTING:**  
2 x 3 W LED Spot
-  **GREASE FILTER:**  
Aluminium
-  **AIR OUTLET:**  
150 mm
-  **WIDTH:**  
40 x 30 cm
-  **ACCESSORIES:**  
Carbon filter, Long Life Filter
-  **EFFICIENCY:**  
650 m3/h



**COMFORT**



**KRW GLASS**



-  **FINISH PAINTED+:**  
Black glass / White Glass / Inox
-  **CONTROLS:**  
Touch control
-  **LIGHTING:**  
2 x 3 W LED Spot
-  **GREASE FILTER:**  
Aluminium
-  **AIR OUTLET:**  
150 mm
-  **WIDTH:**  
40 x 30 cm
-  **ACCESSORIES:**  
Carbon filter, Long Life Filter
-  **EFFICIENCY:**  
650 m3/h



**PREMIUM**



**CUBE W**

-  **FINISH:**  
Black / White / Inox
-  **CONTROLS:**  
Gesture Control + Remote control
-  **LIGHTNING:**  
1 x 12 LED Square
-  **GREASE FILTER:**  
Aluminium
-  **AIR OUTLET:**  
150 mm
-  **WIDTH:**  
40 x 30 cm
-  **ACCESSORIES:**  
Carbon filter, Long Life Filter
-  **EFFICIENCY:**  
650 m3/h











**PREMIUM**

# ISLAND HOODS



**SU**







-  **FINISH:**  
Black / White / Inox
-  **CONTROLS:**  
Soft touch + Remote control
-  **LIGHTING:**  
4 x 3 W LED Spot
-  **GREASE FILTER:**  
Aluminium
-  **AIR OUTLET:**  
220 x 90 mm
-  **WIDTH:**  
90 x 50 / 90 x 60 / 100 x 50 / 100 x 60 / 120 x 60 cm
-  **ACCESORIES:**  
Carbon filter, Long Life Filter
-  **EFFICIENCY:**  
Customized



**COMFORT**



**SU GLASS**







-  **FINISH:**  
Black glass / White Glass
-  **CONTROLS:**  
Soft touch + Remote control
-  **LIGHTING:**  
4 x 3 W LED Spot
-  **GREASE FILTER:**  
Aluminium
-  **AIR OUTLET:**  
220 x 90 mm
-  **WIDTH:**  
90 x 60 cm
-  **ACCESORIES:**  
Carbon filter, Long Life Filter
-  **EFFICIENCY:**  
Customized



**COMFORT**



**SU STRIPE**









-  **FINISH:**  
Black / White / Inox
-  **CONTROLS:**  
Soft touch + Remote control
-  **LIGHTING:**  
2 x 7 W LED Stripe
-  **GREASE FILTER:**  
Aluminium
-  **AIR OUTLET:**  
220 x 90 mm
-  **WIDTH:**  
90 x 60 cm
-  **ACCESORIES:**  
Carbon filter, Long Life Filter
-  **EFFICIENCY:**  
Customized



**COMFORT**



### SU LIGHT



-  **FINISH:**  
Black / White / Inox
-  **CONTROLS:**  
Soft touch + Remote control
-  **LIGHTING:**  
1 x 10 W LED Panel
-  **GREASE FILTER:**  
Aluminium
-  **AIR OUTLET:**  
220 x 90 mm
-  **WIDTH:**  
90 x 60 cm
-  **ACCESSORIES:**  
Carbon filter, Long Life Filter
-  **EFFICIENCY:**  
Customized



**PREMIUM**



### SU FRAME

-  **FINISH:**  
Black / White / Inox
-  **CONTROLS:**  
Soft touch + Remote control
-  **LIGHTING:**  
1 x 12 W LED Square
-  **GREASE FILTER:**  
Aluminium
-  **AIR OUTLET:**  
220 x 90 mm
-  **WIDTH:**  
90 x 60 / 120 x 60 cm
-  **ACCESSORIES:**  
Carbon filter, Long Life Filter
-  **EFFICIENCY:**  
Customized



**PREMIUM**



### SU CLEANLINE

-  **FINISH:**  
Black / White / Inox
-  **CONTROLS:**  
Soft touch + Remote control
-  **LIGHTING:**  
2 x 7 LED Stripe
-  **GREASE FILTER:**  
Aluminium
-  **AIR OUTLET:**  
150 mm
-  **WIDTH:**  
90 x 60 cm
-  **ACCESSORIES:**  
Carbon filter, Long Life Filter
-  **EFFICIENCY:**  
Customized











**PREMIUM**

**ISLAND HOODS**



**OR LAMP**



-  **FINISH:**  
Black glass / Inox + black glass
-  **CONTROLS:**  
Touch control + Remote control
-  **LIGHTING:**  
4 x 1,5 W LED Spot
-  **GREASE FILTER:**  
Aluminium
-  **AIR OUTLET:**  
150 mm
-  **WIDTH:**  
Ø 39 cm
-  **ACCESSORIES:**  
Carbon filter, Long Life Filter
-  **EFFICIENCY:**  
330 m3/h

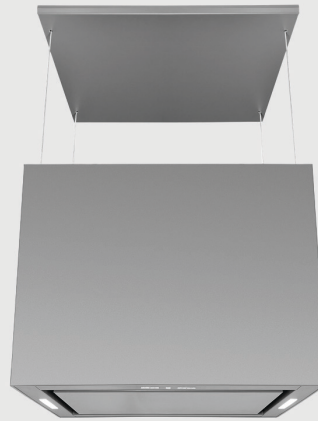

**PREMIUM**



**ANNELLE**







-  **FINISH:**  
Black / White / Inox
-  **CONTROLS:**  
Soft touch + Remote control
-  **LIGHTING:**  
2 x 3 W LED Stripe
-  **GREASE FILTER:**  
Aluminium
-  **AIR OUTLET:**  
150 mm
-  **WIDTH:**  
40 x 30 cm
-  **ACCESSORIES:**  
Carbon filter, Long Life Filter
-  **EFFICIENCY:**  
440 m3/h



**PREMIUM**



**MISS W**







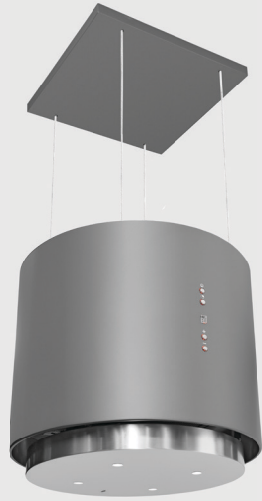

-  **FINISH:**  
Black / White
-  **CONTROLS:**  
Gesture control + Remote control
-  **LIGHTING:**  
1 x 9 W LED Panel
-  **GREASE FILTER:**  
Aluminium
-  **AIR OUTLET:**  
150 mm
-  **WIDTH:**  
Ø 50 cm
-  **ACCESSORIES:**  
Carbon filter, Long Life Filter
-  **EFFICIENCY:**  
475 m3/h



**PREMIUM**



**OR LAMP V2**









-  **FINISH:**  
Black / White / Inox
-  **CONTROLS:**  
Soft touch + Remote control
-  **LIGHTING:**  
4 x 3 W Led
-  **GREASE FILTER:**  
Aluminium
-  **AIR OUTLET:**  
150 mm
-  **WIDTH:**  
Ø 39 cm
-  **ACCESORIES:**  
Carbon filter
-  **EFFICIENCY:**  
Customized



**PREMIUM**



**ISLA**









-  **FINISH:**  
Black / White / Inox
-  **CONTROLS:**  
Soft touch + Remote control
-  **LIGHTING:**  
LED plafon
-  **GREASE FILTER:**  
Aluminium
-  **AIR OUTLET:**  
150 mm
-  **WIDTH:**  
Ø 39 cm
-  **ACCESORIES:**  
Carbon filter
-  **EFFICIENCY:**  
Customized



**PREMIUM**



**OR LAMP V3**

-  **FINISH:**  
Black / White
-  **CONTROLS:**  
Gesture control + Remote control
-  **LIGHTING:**  
1 x 7 W LED plafon
-  **GREASE FILTER:**  
Aluminium
-  **AIR OUTLET:**  
150 mm
-  **WIDTH:**  
Ø 39 cm
-  **ACCESORIES:**  
Carbon filter, Long Life Filter
-  **EFFICIENCY:**  
450 m3/h



**PREMIUM**

**ISLAND HOODS**











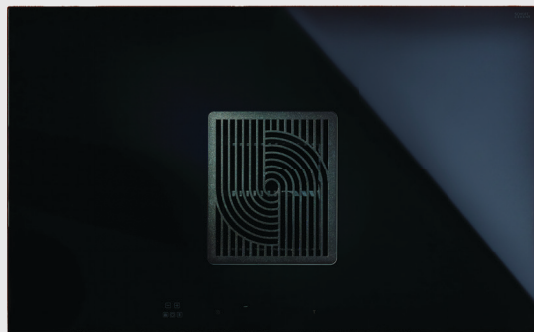

# COUN- TERTOP HOODS



# B3.



**FLOW IN 2.0**





-  **FINISH METAL FRAME:**  
Black / Rose Gold / Gold
-  **CONTROLS:**  
Touch slider
-  **LIGHTING:**  
-
-  **GREASE FILTER:**  
Aluminium
-  **AIR OUTLET:**  
220x90 mm
-  **WIDTH:**  
83 cm
-  **ACCESORIES:**  
Carbon filter, Long Life filter
-  **EFFICIENCY:**  
730 m3/h



**PREMIUM**



**FLOW IN SLIM**









-  **FINISH METAL FRAME:**  
Black / Rose Gold / Gold
-  **CONTROLS:**  
Touch slider
-  **LIGHTING:**  
-
-  **GREASE FILTER:**  
Aluminium
-  **AIR OUTLET:**  
220x90 mm
-  **WIDTH:**  
60 / 72 cm
-  **ACCESORIES:**  
Carbon filter, Long Life filter
-  **EFFICIENCY:**  
550 m3/h



**COMFORT**



**FLOW IN ONE**







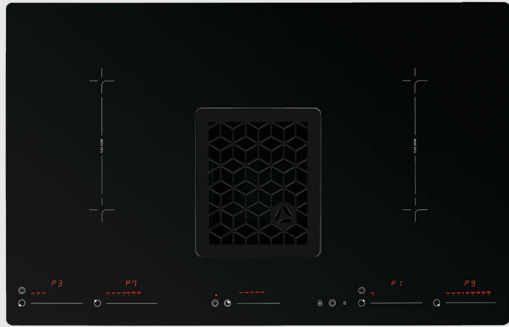

-  **FINISH METAL FRAME:**  
Black / Rose Gold / Gold
-  **CONTROLS:**  
Touch slider
-  **LIGHTING:**  
-
-  **GREASE FILTER:**  
Aluminium
-  **AIR OUTLET:**  
220x90 mm
-  **WIDTH:**  
83 cm
-  **ACCESORIES:**  
Carbon filter, Long Life filter
-  **EFFICIENCY:**  
655 m3/h



**PREMIUM**



**FLOW IN ONE 2.0**









-  **FINISH METAL FRAME:**  
Black / Rose Gold / Gold
-  **CONTROLS:**  
Touch slider
-  **LIGHTING:**  
-
-  **GREASE FILTER:**  
Aluminium
-  **AIR OUTLET:**  
220x90 mm
-  **WIDTH:**  
83 cm
-  **ACCESORIES:**  
Carbon filter, Long Life filter
-  **EFFICIENCY:**  
655 m3/h



**COMFORT**



**MOONDRAFT**

-  **FINISH:**  
Black mat, black glass /  
Inox, black glass
-  **CONTROLS:**  
Touch control
-  **LIGHTING:**  
1 x 10 W LED Stripe
-  **GREASE FILTER:**  
Aluminium
-  **AIR OUTLET:**  
150 mm
-  **WIDTH:**  
60 / 90 cm
-  **ACCESORIES:**  
Carbon filter, Long Life filter
-  **EFFICIENCY:**  
670 / 730 m3/h



**CIARKO DESIGN**

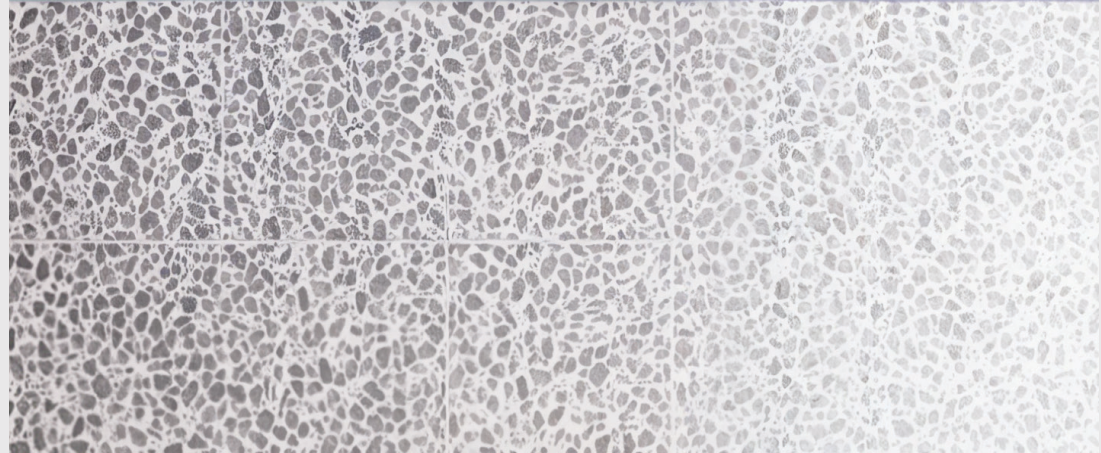
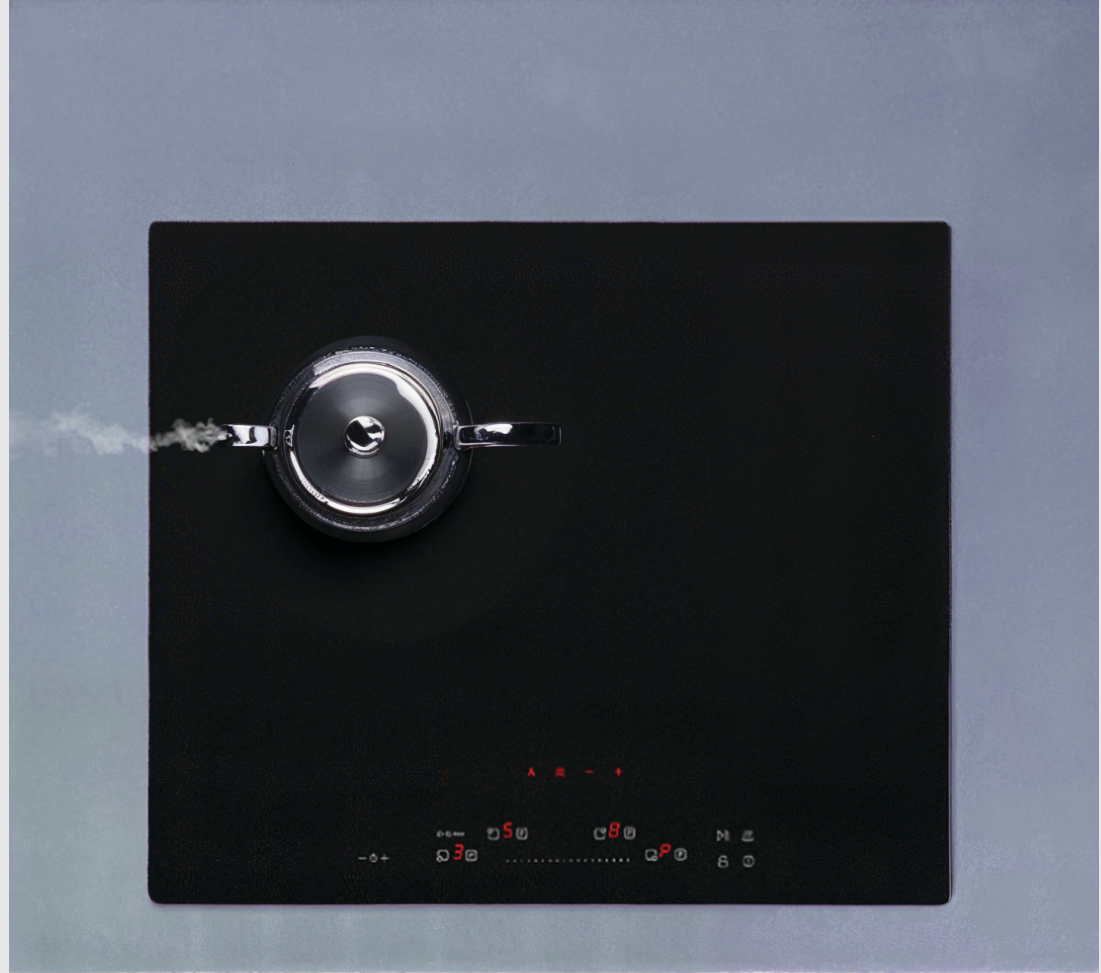



# INDUCTION HOBS







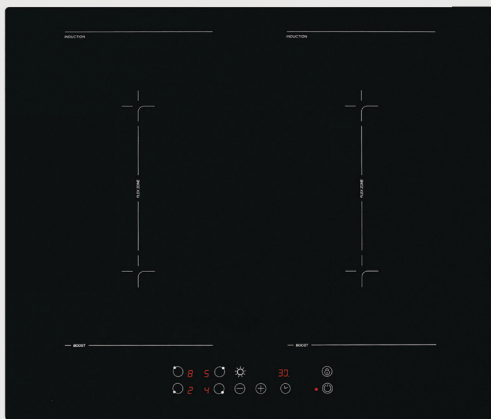



**B7.**

# INDUCTION HOBS







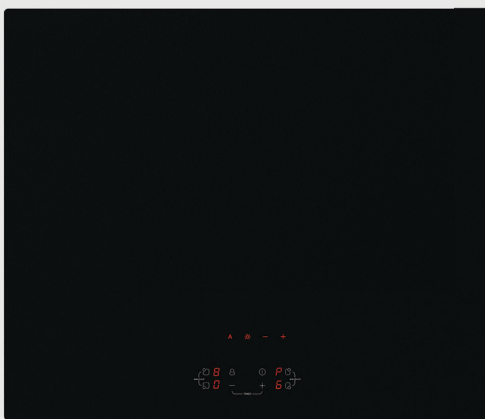



**P01/23**

-  **FINISH:**  
Black
-  **CONTROLS:**  
Touch control
-  **LIGHTING:**  
-
-  **GREASE FILTER:**  
Aluminium
-  **AIR OUTLET:**  
-
-  **WIDTH:**  
60 cm
-  **ACCESSORIES:**  
Carbon filter, Long Life filter
-  **EFFICIENCY:**  
7200 W











**P02/23**

-  **FINISH:**  
Black
-  **CONTROLS:**  
Touch control
-  **LIGHTING:**  
-
-  **GREASE FILTER:**  
Aluminium
-  **AIR OUTLET:**  
-
-  **WIDTH:**  
60 cm
-  **ACCESSORIES:**  
Carbon filter, Long Life filter
-  **EFFICIENCY:**  
7200 W



**P03/23**

-  **FINISH:**  
Black
-  **CONTROLS:**  
Touch control
-  **LIGHTING:**  
-
-  **GREASE FILTER:**  
Aluminium
-  **AIR OUTLET:**  
-
-  **WIDTH:**  
60 cm
-  **ACCESSORIES:**  
Carbon filter, Long Life filter
-  **EFFICIENCY:**  
7200 W





### CULINA SYNC ADVANCED



**FINISH:**  
Black



**CONTROLS:**  
Touch control



**LIGHTING:**  
-



**GREASE FILTER:**  
-



**AIR OUTLET:**  
-



**WIDTH:**  
60 cm



**ACCESSORIES:**  
-



**EFFICIENCY:**  
7200 W



### CULINA SYNC ULTIMATE



**FINISH:**  
Black



**CONTROLS:**  
TFT Screen



**LIGHTING:**  
-



**GREASE FILTER:**  
-



**AIR OUTLET:**  
-



**WIDTH:**  
77,5 cm



**ACCESSORIES:**  
-



**EFFICIENCY:**  
7200 W





 **CIARKO**<sup>®</sup>  
DESIGN



**MODELS**



**91.** 



**MINIMAL 7**









-  **FINISH:**  
Black
-  **CONTROLS:**  
Gesture Control + Remote control
-  **LIGHTING:**  
2 x 3 W LED Strip
-  **GREASE FILTER:**  
Aluminium
-  **AIR OUTLET:**  
150 mm
-  **WIDTH:**  
60 / 74 / 90 cm
-  **ACCESSORIES:**  
Carbon filter, Long Life Filter
-  **EFFICIENCY:**  
650 / 660 / 670 m3/h



**CIARKO DESIGN**



**SU MINI**









-  **FINISH:**  
Black / White
-  **CONTROLS:**  
Gesture Control + Remote control
-  **LIGHTING:**  
1 x 6 W LED Panel
-  **GREASE FILTER:**  
Aluminium
-  **AIR OUTLET:**  
150 mm
-  **WIDTH:**  
60 / 74 cm
-  **ACCESSORIES:**  
Carbon filter, Long Life Filter
-  **EFFICIENCY:**  
680 / 690 m3/h



**CIARKO DESIGN**



**UNO**

-  **FINISH:**  
Black glass / White glass
-  **CONTROLS:**  
Gesture Control + Remote control
-  **LIGHTING:**  
1 x 4 W LED Stripe
-  **GREASE FILTER:**  
Aluminium
-  **AIR OUTLET:**  
150 mm
-  **WIDTH:**  
55 / 74 cm
-  **ACCESSORIES:**  
Carbon filter, Long Life Filter
-  **EFFICIENCY:**  
705 / 740 m3/h



















**CIARKO DESIGN**



**DUO**

**AURA**









-  **FINISH:**  
Black glass / White glass
-  **CONTROLS:**  
Gesture Control + Remote control
-  **LIGHTING:**  
2 x 8 W LED Stripe
-  **GREASE FILTER:**  
Aluminium
-  **AIR OUTLET:**  
150 mm
-  **WIDTH:**  
55 / 74 cm
-  **ACCESORIES:**  
Carbon filter, Long Life Filter
-  **EFFICIENCY:**  
710 / 740 m3/h

-  **FINISH:**  
Black
-  **CONTROLS:**  
Gesture Control + Remote control
-  **LIGHTING:**  
1 x 6 W LED Stripe
-  **GREASE FILTER:**  
Aluminium
-  **AIR OUTLET:**  
150 mm
-  **WIDTH:**  
55 / 74 cm
-  **ACCESORIES:**  
Carbon filter, Long Life Filter
-  **EFFICIENCY:**  
680 / 690 m3/h





**JOKER UNO**







-  **FINISH:**  
Black glass / White glass
-  **CONTROLS:**  
Gesture Control + Remote control
-  **LIGHTING:**  
1 x 7 W LED Stripe
-  **GREASE FILTER:**  
Aluminium
-  **AIR OUTLET:**  
220 x 90 mm
-  **WIDTH:**  
55 / 74 cm
-  **ACCESORIES:**  
Carbon filter, Long Life Filter, SpaceMax System
-  **EFFICIENCY:**  
650 / 660 m3/h



**CIARKO DESIGN**



**JOKER DUO**

-  **FINISH:**  
Black glass / White glass
-  **CONTROLS:**  
Gesture Control + Remote control
-  **LIGHTING:**  
2 x 7 W LED Stripe
-  **GREASE FILTER:**  
Aluminium
-  **AIR OUTLET:**  
220 x 90 mm
-  **WIDTH:**  
55 / 74 cm
-  **ACCESORIES:**  
Carbon filter, Long Life Filter, SpaceMax System
-  **EFFICIENCY:**  
650 / 660 m3/h



**CIARKO DESIGN**





# SPACE MAX JOKER.

The original 7 cm deep air duct intended for the Uno Joker and Duo Joker hoods ensures safe removal of **moist air also in the absorber mode** (thanks to a special Ciarko Design accessory in the SpaceMAX Joker System). **Can be adjusted to any width, height and depth of the cabinet.** Ergonomic and the aesthetic layout of the cabinet (rectangle) means as much as **80% of the space saved** in the cabinet! See more on Ciarko Design Portfolio.



**ILLUMIA**









-  **FINISH:**  
Black glass / White glass
-  **CONTROLS:**  
Gesture Control + Touch control  
+ Remote control
-  **LIGHTING:**  
1 x 12 W LED Stripe
-  **GREASE FILTER:**  
Aluminium
-  **AIR OUTLET:**  
150 mm
-  **WIDTH:**  
90 cm
-  **ACCESORIES:**  
Carbon filter, Long Life Filter
-  **EFFICIENCY:**  
730 m3/h



**CIARKO DESIGN**



**TRIO**









-  **FINISH:**  
Black glass + gold / Black glass + rose  
gold / Inox
-  **CONTROLS:**  
Gesture Control + Touch control  
+ Remote control
-  **LIGHTING:**  
2 x 3 W LED Spot
-  **GREASE FILTER:**  
Aluminium
-  **AIR OUTLET:**  
150 mm
-  **WIDTH:**  
90 cm
-  **ACCESORIES:**  
Carbon filter, Long Life Filter
-  **EFFICIENCY:**  
740 m3/h



**CIARKO DESIGN**



**ECLIPSE**









-  **FINISH:**  
Inox / black+gold / white+gold /  
black + inox / black + rose gold
-  **CONTROLS:**  
Gesture Control + Touch control  
+ Remote control
-  **LIGHTING:**  
2 x 3 LED Stripe
-  **GREASE FILTER:**  
Aluminium
-  **AIR OUTLET:**  
150 mm
-  **WIDTH:**  
60 cm
-  **ACCESORIES:**  
Carbon filter, Long Life Filter
-  **EFFICIENCY:**  
735 m3/h



**CIARKO DESIGN**











**MINIMAL 8**

-  **FINISH:**  
Black
-  **CONTROLS:**  
Gesture control + Remote control
-  **LIGHTING:**  
3 x 3 W LED Stripe
-  **GREASE FILTER:**  
Baffle filter
-  **AIR OUTLET:**  
150 mm
-  **WIDTH:**  
90 cm
-  **ACCESORIES:**  
Carbon filter, Long Life Filter
-  **EFFICIENCY:**  
720 m3/h











**T-LIGHT**

-  **FINISH:**  
Black
-  **CONTROLS:**  
Gesture control + Remote control
-  **LIGHTING:**  
1 x 10 W LED Panel
-  **GREASE FILTER:**  
Aluminium
-  **AIR OUTLET:**  
150 mm
-  **WIDTH:**  
60 / 90 cm
-  **ACCESORIES:**  
Carbon filter, Long Life Filter
-  **EFFICIENCY:**  
730 / 740 m3/h





**MINIMAL 3**

-  **FINISH:**  
Black
-  **CONTROLS:**  
Gesture control + Remote control
-  **LIGHTING:**  
2 x 3 W LED Stripe
-  **GREASE FILTER:**  
Baffle filter
-  **AIR OUTLET:**  
150 mm
-  **WIDTH:**  
90 cm
-  **ACCESORIES:**  
Carbon filter, Long Life Filter
-  **EFFICIENCY:**  
610 m3/h





### TUBUS









-  **FINISH:**  
Black / White / Inox / Gold Steel / Gold / Rose Gold
-  **CONTROLS:**  
Gesture Control + Remote control
-  **LIGHTING:**  
1 x 8 W LED Circle
-  **GREASE FILTER:**  
Aluminium
-  **AIR OUTLET:**  
150 mm
-  **WIDTH:**  
Ø 38 cm
-  **ACCESORIES:**  
Carbon filter, Long Life Filter
-  **EFFICIENCY:**  
670 m3/h



**CIARKO DESIGN**



### MONOGRAM

-  **FINISH:**  
Black / White / Rose Gold / Gold / Green / Ecru
-  **CONTROLS:**  
Gesture Control + Remote control
-  **LIGHTING:**  
1 x 8 W LED Circle
-  **GREASE FILTER:**  
Aluminium
-  **AIR OUTLET:**  
150 mm
-  **WIDTH:**  
Ø 38 cm
-  **ACCESORIES:**  
Carbon filter, Long Life Filter
-  **EFFICIENCY:**  
670 m3/h



**CIARKO DESIGN**

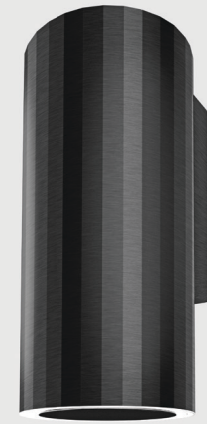

### ROTO

-  **FINISH:**  
Black / White / Gold / Gun metal
-  **CONTROLS:**  
Gesture Control + Remote control
-  **LIGHTING:**  
1 x 8 LED Circle
-  **GREASE FILTER:**  
Aluminium
-  **AIR OUTLET:**  
150 mm
-  **WIDTH:**  
Ø 38 cm
-  **ACCESORIES:**  
Carbon filter, Long Life Filter
-  **EFFICIENCY:**  
670 m3/h









**CIARKO DESIGN**



















**MINIMAL 4**

**MINIMAL 5**

**MINIMAL 6**

-  **FINISH:**  
Black
-  **CONTROLS:**  
Gesture Control + Remote control
-  **LIGHTING:**  
1 x 4 W LED Stripe
-  **GREASE FILTER:**  
Baffle filter
-  **AIR OUTLET:**  
150 mm
-  **WIDTH:**  
60 / 90 cm
-  **ACCESSORIES:**  
Carbon filter, Long Life Filter
-  **EFFICIENCY:**  
700 / 715 m3/h

-  **FINISH:**  
Black
-  **CONTROLS:**  
Gesture Control + Remote control
-  **LIGHTING:**  
1 x 4 W LED Spot
-  **GREASE FILTER:**  
Baffle filter
-  **AIR OUTLET:**  
150 mm
-  **WIDTH:**  
60 / 90 cm
-  **ACCESSORIES:**  
Carbon filter, Long Life Filter
-  **EFFICIENCY:**  
700 / 715 m3/h

-  **FINISH:**  
Black
-  **CONTROLS:**  
Gesture Control + Remote control
-  **LIGHTING:**  
1 x 4 W LED Spot
-  **GREASE FILTER:**  
Baffle filter
-  **AIR OUTLET:**  
150 mm
-  **WIDTH:**  
60 / 90 cm
-  **ACCESSORIES:**  
Carbon filter, Long Life Filter
-  **EFFICIENCY:**  
700 / 715 m3/h





## MONO



### FINISH:

Black, Black / Black Silver / White / Rose Gold / Gold / Green / Ecrú



### CONTROLS:

Mechanical + Gesture Control + Remote control



### LIGHTING:

1 x 4 W LED Spot



### GREASE FILTER:

Aluminium



### AIR OUTLET:

150 mm



### WIDTH:

60 / 80 cm



### ACCESORIES:

Carbon filter, Long Life Filter



### EFFICIENCY:

650 / 750 m3/h



**CIARKO DESIGN**



## SIMPLE



### FINISH:

Black Gold / Black, Rose Gold / Rose Gold / Inox



### CONTROLS:

Mechanical + Gesture Control + Remote control



### LIGHTING:

1 x 5 W LED Stripe



### GREASE FILTER:

Aluminium



### AIR OUTLET:

150 mm



### WIDTH:

60 cm



### ACCESORIES:

Carbon filter, Long Life Filter



### EFFICIENCY:







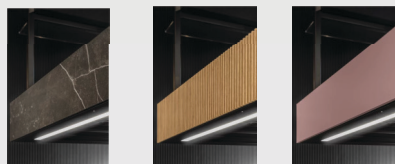
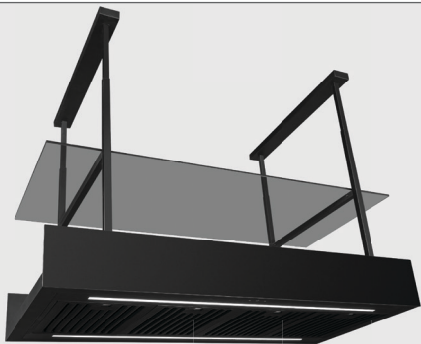

650 m3/h



**CIARKO DESIGN**



**MINIMAL 1**

-  **FINISH:**  
Black (personalized side panels)
-  **CONTROLS:**  
Gesture Control + Remote control
-  **LIGHTING:**  
2 x 7 W LED Stripe
-  **GREASE FILTER:**  
Baffle filter
-  **AIR OUTLET:**  
-
-  **WIDTH:**  
90 / 120 cm
-  **ACCESORIES:**  
Carbon filter, Long Life Filter
-  **EFFICIENCY:**  
550 m3/h



**CIARKO DESIGN**



**MINIMAL 2**







-  **FINISH:**  
Black
-  **CONTROLS:**  
Gesture Control + Remote control
-  **LIGHTING:**  
1 x 12 W LED Square
-  **GREASE FILTER:**  
Aluminium
-  **AIR OUTLET:**  
150 mm
-  **WIDTH:**  
120 / 180 cm
-  **ACCESORIES:**  
Carbon filter, Long Life Filter
-  **EFFICIENCY:**  
675 m3/h



**CIARKO DESIGN**



**TUBUS W LONG**









-  **FINISH:**  
Black / White / Inox
-  **CONTROLS:**  
Touch control
-  **LIGHTING:**  
1 x 7 W LED Spot
-  **GREASE FILTER:**  
Aluminium
-  **AIR OUTLET:**  
150 mm
-  **WIDTH:**  
Ø 39 cm
-  **ACCESORIES:**  
Carbon filter, Long Life Filter
-  **EFFICIENCY:**  
670 m3/h



**CIARKO DESIGN**



### TUBUS W







-  **FINISH:**  
Black / White / Inox / Gold Steel / Gold / Rose Gold
-  **CONTROLS:**  
Gesture Control + Remote control
-  **LIGHTING:**  
1 x 8 W LED Circle
-  **GREASE FILTER:**  
Aluminium
-  **AIR OUTLET:**  
150 mm
-  **WIDTH:**  
Ø 38 cm
-  **ACCESORIES:**  
Carbon filter, Long Life Filter
-  **EFFICIENCY:**  
670 m3/h



**CIARKO DESIGN**



### MONOGRAM W

-  **FINISH:**  
Black / White / Rose Gold / Gold / Green / Ecru
-  **CONTROLS:**  
Gesture Control + Remote control
-  **LIGHTING:**  
1 x 8 W LED Circle
-  **GREASE FILTER:**  
Aluminium
-  **AIR OUTLET:**  
150 mm
-  **WIDTH:**  
Ø 38 cm
-  **ACCESORIES:**  
Carbon filter, Long Life Filter
-  **EFFICIENCY:**  
670 m3/h



**CIARKO DESIGN**



### ROTO W









-  **FINISH:**  
Black / White / Gold / Gun metal
-  **CONTROLS:**  
Gesture Control + Remote control
-  **LIGHTING:**  
1 x 8 LED Circle
-  **GREASE FILTER:**  
Aluminium
-  **AIR OUTLET:**  
150 mm
-  **WIDTH:**  
Ø 38 cm
-  **ACCESORIES:**  
Carbon filter, Long Life Filter
-  **EFFICIENCY:**  
670 m3/h



**CIARKO DESIGN**



**MONO W**









-  **FINISH:**  
Black / Black Silver / Black / White / Rose Gold / Gold / Green / Ecrú
-  **CONTROLS:**  
Mechanical + Gesture Control + Remote control
-  **LIGHTING:**  
1 x 5 W LED Spot
-  **GREASE FILTER:**  
Aluminium
-  **AIR OUTLET:**  
-
-  **WIDTH:**  
90 cm
-  **ACCESORIES:**  
Carbon filter, Long Life Filter
-  **EFFICIENCY:**  
550 m3/h



**CIARKO DESIGN**



**PIU LIGHT**









-  **FINISH:**  
Black / Ecrú / Gold
-  **CONTROLS:**  
Gesture Control + Remote control
-  **LIGHTING:**  
1 x 11 W LED Panel
-  **GREASE FILTER:**  
Aluminium
-  **AIR OUTLET:**  
-
-  **WIDTH:**  
60 / 80 cm
-  **ACCESORIES:**  
Carbon filter, Long Life Filter
-  **EFFICIENCY:**  
460 / 640 m3/h



**CIARKO DESIGN**



**MONO LIGHT**

-  **FINISH:**  
Black / Ecrú / Gold
-  **CONTROLS:**  
Gesture Control + Remote control
-  **LIGHTING:**  
1 x 11 W LED Panel
-  **GREASE FILTER:**  
Aluminium
-  **AIR OUTLET:**  
-
-  **WIDTH:**  
60 / 80 cm
-  **ACCESORIES:**  
Carbon filter, Long Life Filter
-  **EFFICIENCY:**  
460 / 640 m3/h



**CIARKO DESIGN**



**SU LIGHT**

**SU FRAME**



**FINISH:**  
Black / White / Inox



**CONTROLS:**  
Soft touch + Remote control



**LIGHTING:**  
1 x 10 W LED Panel



**GREASE FILTER:**  
Aluminium



**AIR OUTLET:**  
220 x 90 mm



**WIDTH:**  
90 x 60 cm



**ACCESORIES:**  
Carbon filter, Long Life Filter



**EFFICIENCY:**  
750 m3/h



**FINISH:**  
Black / White / Inox



**CONTROLS:**  
Soft touch + Remote control



**LIGHTING:**  
1 x 12 W LED Square



**GREASE FILTER:**  
Aluminium



**AIR OUTLET:**  
220 x 90 mm



**WIDTH:**  
90 x 60 / 120 x 60 cm



**ACCESORIES:**  
Carbon filter, Long Life Filter



**EFFICIENCY:**  
750 m3/h



**CIARKO DESIGN**

**CIARKO DESIGN**

# CONTROL PANEL OPTIONS.



**SOFT TOUCH CONTROL**



**SOFT TOUCH CONTROL**



**SOFT TOUCH CONTROL**



**TOUCH CONTROL (WITH DIFFERENT ICON DESIGNS)**



**TOUCH CONTROL (WITH DIFFERENT ICON DESIGNS) AND DISPLAY**



**MECHANICAL  
BUTTONS  
"PUSH-PUSH"**



**MECHANICAL  
BUTTONS  
"PUSH-PUSH"**

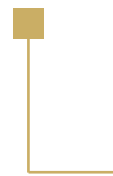

**MECHANICAL  
SLIDER  
CONTROL**



**MECHANICAL  
ROCKER  
SWITCH**

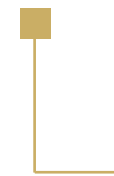

**MECHANICAL  
ROUND ROTARY  
SWITCH**

# LIGHTING SOLUTIONS.

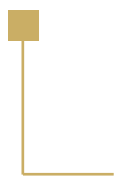

**LED STRIPE  
-SIZE OPTION**

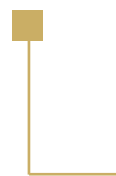

**LED STRIPES**

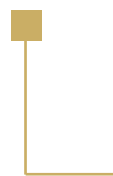

**LED STRIPE**



**LED SPOT**



**LED MOVABLE -  
VARIOUS COLORS**



**LED CANDLE  
BULB**



**LED CANDLE  
BULBS**

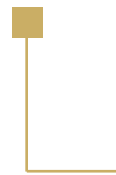
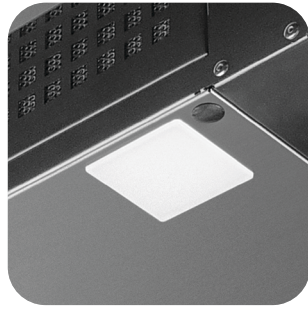

**LED  
SQUARE**



**LED PANELS**

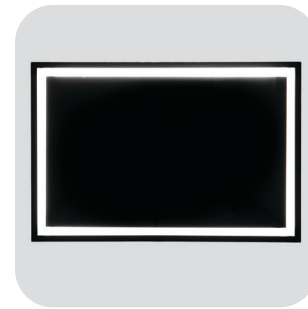

**LED  
SQUARED  
PANELS**



 **CIARKO**<sup>®</sup>

KITCHEN COOKER HOODS AND HOBS

**Ciarko Spółka z ograniczoną  
odpowiedzialnością Sp. K.**

ul. Okulickiego 10  
38-500 Sanok, Polska  
NIP 6852210122

phone +48 13 46 53 500 / fax. +48 13 46 53 509

ciarko@ciarko.pl / handel@ciarko.pl

**www.ciarko.com**